

Status: 06/2024

**cab**  
*we identify more*



Print and  
apply systems  
for industrial operation

**HERMES Q**

Made in Germany



## Data security in label printing

Modern manufacture sees marking systems work autonomous, interact among each other, with host computers or a plant control unit. Data security is a key issue. The integration of components, their administration and authentication are sensitive tasks demanded from the corporate IT. cab systems developed for printing and applying labels provide proper features by default, fairly protecting your data in a network.



Permissions can be assigned to users and restricted by passwords.



Firmware updates are verified for integrity before installation.



Access to network services (HTTP, FTP, VNC, OPC UA etc.) is possible only for users with authorization. Network services can be switched on or off.



Network protocols can be encrypted using TLS/SSL. To connect securely in a network, a certificate as required is installed in the device ex factory.



Wireless interfaces (WLAN, Bluetooth) can be switched on or off. WPA2, WPA2 Enterprise and WPA3 levels of security are supported.



Printers in a network can be authorized securely. IEEE 802.1X network standard is supported.



USB slots can be locked and access to external storage media be denied.

All the current cab printing systems are based on the same electronics and firmware. The printer language is the same, so are interfaces and memory. Any further developed operating system or driver is available immediately on every device. Resets to default settings are PIN-protected.



## Contents

<b>Page 2</b> .....	cabPROTECT
<b>Pages 4 - 13</b> .....	HERMES Q
<b>Pages 14 - 15</b> .....	Software
<b>Pages 16 - 33</b> .....	Applicators
<b>Page 34</b> .....	Tools to assemble
<b>Pages 35 - 36</b> .....	Floor stands
<b>Pages 38 - 42</b> .....	Delivery program
<b>Page 43</b> .....	cab product overview

# HERMES Q

Printing labels and applying them automatically in production lines

1.1



## The slim one

to print small labels

Label printer		HERMES Q2	
Printable resolution	dpi	300	600
Print speed	up to mm/s	300	150
Print width	up to mm	56.9	54.1
Label roll outside diameters	mm	205 / 305	
Label width	up to mm	58	

1.2



## The universal one

An industrial bestseller, providing a wide range of accessories

Label printer		HERMES Q4.3		HERMES Q4	
Printable resolution	dpi	200	300	300	600
Print speed	up to mm/s	300	300	300	150
Print width	up to mm	104	108.4	105.7	105.7
Label roll outside diameters	mm	205 / 305			
Label width	up to mm	114			

1.3



## The wide one

to print Odette, UCC and GS1 labels in logistics applications

Label printer		HERMES Q6.3	
Printable resolution	dpi	200	300
Print speed	up to mm/s	250	250
Print width	up to mm	168	162.6
Label roll outside diameters	mm	205 / 305	
Label width	up to mm	174	

## Sample applications



## Label rolls

All units can provide an unwinder for picking up rolls with maximum diameter either 205 mm or 305 mm.



## Directions to which dispense labels

All units can be designed for providing labels either to the left or to the right.



## Orientations of assembly

All the units can be rotated vertically by at most 360° or assembled in horizontal orientation.

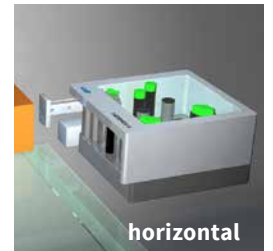
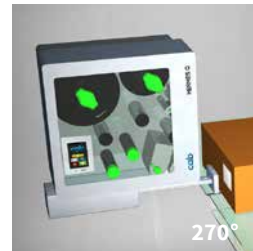
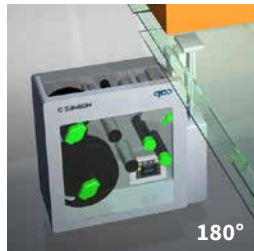
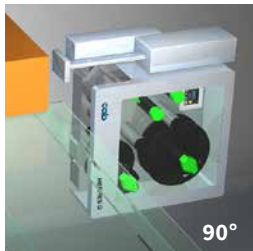
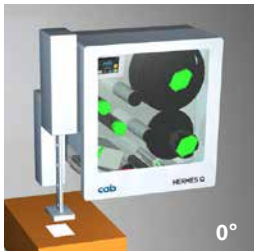

# HERMES Q in detail



## 1 Operation panel

Self-explanatory symbols are on display. The device can thus be operated intuitively and settings be configured easily.

## 2 Ribbon holder

On the basis of three-part tightening axes, ribbons can be replaced easily and quickly.

## 3 Rugged metal chassis

It is made of cast aluminum. All the parts are assembled to it.

## 4 Applicator

It is assembled to hinge pins. It can be pivoted in case of maintenance or if materials have to be replaced.

## 5 Pressing plungers

One is fixed near the chassis wall. The second one is pushed to the label margin, as far as necessary to evoke a good print image.

## 6 Print head

Units of the same width are interchangeable. Replacement requires only few steps.

## 7 Print roller

It can be removed/inserted quickly in cases of cleaning or wear.

## 8 Peel-off plate

Pivoting improves labels be applied to packages.

## 9 Label unwinder

A swing arm and an integral brake enable labels be unwound at constant force.

## 10 Liner rewinder

Subsequent to all the labels been dispensed, the entire liner tape is rewound. On the basis of a three-part tightening axle, a liner tape can be inserted and removed easily.

## 11 Pulling system

A liner tape is clamped between a draw roller and a pinch roller. Labels are dispensed using feed synchronous to the print roller.

## 12 Label sensor

Imprint is precisely set on spot on a label and materials ending detected by a transmissive or a reflective sensor.

## Accurate imprint

The smaller a label, the higher are the demands regarding the accuracy of an imprint. Print offset can be reduced by  $\pm 0.2$  mm using adjustable slip correction.

## Print heads



**Units of the same width are interchangeable.**  
**They are detected by the CPU automatically and calibrated.**  
**The print distance to the locating edge can be adjusted.**

Major data such as the operational performance, maximum operating temperature and heat energy are recorded on the print head. Data can be read at the factory.

**Print heads provided for HERMES Q2, HERMES Q4 - 300, 600 dpi**

- sharp-edge print images
- e.g. when printing small fonts and graphics on typeplates
- e.g. when printing on materials requires high energy needs

**Print heads provided for HERMES Q4.3, HERMES Q6.3 - 200, 300 dpi**  
 persistent; when labeling in rough settings and thermal direct method

## Print rollers



**Two types of materials:**

**Print rollers DR**

providing a synthetic rubber coating  
 They enable highly accurate imprint and are provided by default.

**Print rollers DRS**

providing a silicone coating  
 Product life is extra long, taken a higher print offset into account.

## Interfaces



- 1 Slot to insert a **SD memory card**
- 2 **2 USB hosts** to connect a service key, USB memory stick, keyboard, barcode scanner, USB WLAN stick, warning light, an external operation panel
- 3 **USB 2.0 Hi-Speed** to connect a PC
- 4 **Ethernet 10/100 Mbit/s**
- 5 **RS232C** 1,200 to 230,400 baud /8 bits
- 6 **Digital I/O interface;** socket connector SUB-D, 25 pins compliant with IEC/EN 61131-2, types 1+3;  
 All the inputs and outputs are isolated galvanically and protect from reverse polarity. In addition, outputs are short-circuit proof

**PNP inputs**

Start printing or labeling  
 Print first label  
 Reprint  
 Delete print job  
 Label removed  
 Stop printing or labeling  
 Label feed  
 Label rotated by 90°  
 (to be applied by applicator 4214)  
 Pause  
 Reset

**PNP, NPN outputs**

Device ready  
 Print data available  
 Initial / upper end position  
 Paper feed ON  
 Label in transfer position  
 Label application / lower end position  
 Pre-warning to a ribbon ending  
 Pre-warning to a label web ending  
 End of a ribbon and/or a label web  
 Collective error

Option:

- 7 **2 port Ethernet switch 10/100 Mbit/s**

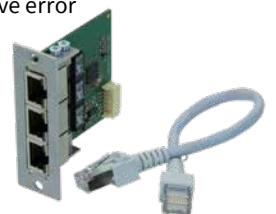







# Operation panel

**Self-explanatory symbols are on display. The device can thus be operated intuitively and settings be configured easily.**

- 1 **LED:** Power ON
- 2 **Status bar:** data reception, record data stream, pre-warning to a ribbon ending, SD memory card / USB memory stick plugged in, WLAN, Ethernet, USB slave, time
- 3 **Printer status:** ready, pause, number of labels printed in a print job, label in transfer position, awaiting external start signal
- 4 **USB slot** to connect a service key or a memory stick, to transfer data to the IFFS memory

## 5 Operation

-  Printing and applying labels in individual steps
-  Jump to menu
-  Reprint the latest label
-  Interrupt and continue a print job
-  Stop and delete all print jobs
-  Label feed



**Setup options**



**Print parameters**

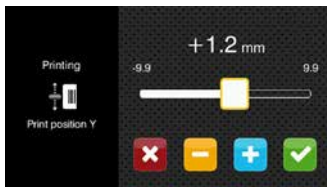

**Print offset Y**



**Print speeds**

**Landscape or portrait display, depending from the orientation of assembly**



**Printer rotated by 90°**



**Video tutorials**

# External operation panel

If the operation panel of a printer cannot be accessed, an additional external one can be plugged.

Same functionality as on the printer

Landscape or portrait mode

Operability as desired on the external operation panel or on the printer

Printer connectivity: USB 2.0 Hi-Speed device

- 1 **LED:** Power ON
- 2 **USB port** to plug a service key or a memory stick, to transfer data to the IFFS memory
- 3 **Connecting USB cable** for power supply  
cab provides specified cables. Lengths are 1.8 m to 16 m.











# Accessories

Accessorial products are plugged or screwed to a printer by the customer.

Pos.	Designation	roll Ø	205	305	1.1	1.2		1.3
					HERMES Q2	HERMES Q4.3	HERMES Q4	HERMES Q6.3
2.1	SD memory card		●	●	<input type="checkbox"/>	<input type="checkbox"/>	<input type="checkbox"/>	<input type="checkbox"/>
2.2	USB memory stick		●	●	<input type="checkbox"/>	<input type="checkbox"/>	<input type="checkbox"/>	<input type="checkbox"/>
2.3	USB WLAN stick		●	●	<input type="checkbox"/>	<input type="checkbox"/>	<input type="checkbox"/>	<input type="checkbox"/>
2.4	USB WLAN stick including a rod antenna		●	●	<input type="checkbox"/>	<input type="checkbox"/>	<input type="checkbox"/>	<input type="checkbox"/>
2.6	Product sensor, 3 pins		●	●	-	<input type="checkbox"/>	<input type="checkbox"/>	<input type="checkbox"/>
2.7	Product sensor, 25 pins		●	●	<input type="checkbox"/>	<input type="checkbox"/>	<input type="checkbox"/>	<input type="checkbox"/>
2.8	I/O interface connector SUB-D, 25 pins		●	●	<input type="checkbox"/>	<input type="checkbox"/>	<input type="checkbox"/>	<input type="checkbox"/>
2.9	Warning light		●	●	<input type="checkbox"/>	<input type="checkbox"/>	<input type="checkbox"/>	<input type="checkbox"/>
2.10	External operation panel		●	●	<input type="checkbox"/>	<input type="checkbox"/>	<input type="checkbox"/>	<input type="checkbox"/>
	Connecting USB cable		●	●	<input type="checkbox"/>	<input type="checkbox"/>	<input type="checkbox"/>	<input type="checkbox"/>
2.11	Label selection - I/O box		●	●	<input type="checkbox"/>	<input type="checkbox"/>	<input type="checkbox"/>	<input type="checkbox"/>
2.12	Hand switch TR2		●	●	<input type="checkbox"/>	<input type="checkbox"/>	<input type="checkbox"/>	<input type="checkbox"/>
2.13	Foot switch		●	●	<input type="checkbox"/>	<input type="checkbox"/>	<input type="checkbox"/>	<input type="checkbox"/>
2.14	Connecting RS232 C cable		●	●	<input type="checkbox"/>	<input type="checkbox"/>	<input type="checkbox"/>	<input type="checkbox"/>
2.15	Scanner CC200		●	●	<input type="checkbox"/>	<input type="checkbox"/>	<input type="checkbox"/>	<input type="checkbox"/>

2.1		<b>SD memory card</b>
2.2		<b>USB memory stick</b>
2.3		<b>USB WLAN stick</b> 2.4 GHz 802.11b/g/n hotspot or infrastructure mode
2.4		<b>USB WLAN stick including a rod antenna</b> to extend the range of operation 2.4 GHz 802.11b/g/n + 5 GHz 802.11a/n/ac hotspot or infrastructure mode
2.6		<b>Product sensor, 3 pins</b> to be attached to a front side applicator, a vacuum belt applicator or an air jet box. Labels are triggered to be applied as soon as a product has been detached, e.g. on a conveyor belt.
2.7		<b>Product sensor, 25 pins</b> Labels are triggered to be applied as soon as a product has been detached, e.g. on a conveyor belt.
2.8		<b>I/O interface connector SUB-D, 25 pins</b> All control signals can be attached to the I/O interface using clamping screws.
2.9		<b>Warning light</b> In addition to the information indicated on the display of a printer, states are signalled. <b>Red</b> Collective error <b>Yellow</b> Pre-warning to a label web or a ribbon ending <b>Green</b> Device ready USB cable (1 m) to connect to HERMES Q Assembly materials are provided for vertical printer installation only. <b>1</b> Chassis assembly <b>2</b> Bracket assembly

2.10		<b>External operation panel</b> If the operation panel of a printer cannot be accessed, an additional external one can be plugged. Same functionality as on the printer Landscape or portrait mode Operability as desired on the external operation panel or on the printer
		Printer connectivity: USB 2.0 Hi-Speed device cab provides specified <b>connecting USB cables</b> for power supply. Lengths are 1.8 m to 16 m.
2.11		<b>Label selection - I/O box</b> A maximum of 16 different labels can be selected from a memory card by a master control unit, e.g. PLC.
2.12		<b>Hand switch TR2</b> to be attached to the I/O interface
2.13		<b>Foot switch</b> to be attached to the I/O interface
2.14		<b>Connecting RS232 C cable</b> 9/9 pins, 3 m
2.15		<b>Scanner CC200</b> provided on request

**Options** are parts or units to perform special functions. They are assembled to a printer in addition to or instead of standards.

If order implies options be assembled ex factory, the part numbers of such printers and options are added by .250. Options delivered separately are added by .001.

Pos.	Designation	roll Ø	205	305	HERMES Q2	HERMES Q4.3	HERMES Q4	HERMES Q6.3	.250	.001
3.1	Automatic ribbon saving		●	●	-	□	□	□	●	-
3.2	UHF RFID module		●	●	-	□	□	□	●	-
3.3	Label unwinder K40		●	●	□	□	□	□	●	●
3.4/3.5	Adapters 40/50 and 76/100		●	●	□	□	□	□	●	●
3.6	Spacers		●	-	□	□	□	-	●	●
3.7	Margin stop 10		●	-	□	□	□	□	●	●
3.8	Cover		●	-	□	□	□	□	●	●
3.9	Print head pressure system, reduced force		●	●	□	□	-	□	●	●
3.10	Extended peel-off plate (+10 mm)		●	●	□	□	□	□	●	●
3.11	Print roller DRS		●	●	□	□	□	□	●	●
3.12	Antistatic brush		●	●	□	□	□	-	●	●
3.13	Draw roller ZS		●	●	□	□	□	□	●	●
3.14	Interface for plugging an external label sensor		●	●	□	□	□	□	●	●
3.15	2 port Ethernet switch 10/100 Mbit/s		●	●	□	□	□	□	●	●
3.16	Label sensor, modified		●	●	□	-	-	-	●	●



3.1

assembly  
ex factory only

### Automatic ribbon saving

Use is recommended in cases of at least 60 mm unprinted area on a label. While labels are fed, the print head is lifted and the ribbon stopped, resulting in less material consumption.



3.2

assembly to  
a printer ex factory  
excludes automatic  
ribbon saving

### UHF RFID module

Read/write antennas are assembled directly to a print head or a feeding unit. Using a 4214 applicator enables defective labels be ejected.



See information on [www.cab.de/en/rfid](http://www.cab.de/en/rfid)



3.3

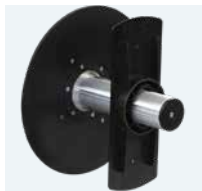

3.4

### Adapter 40/50

to pick up label rolls having a core diameter of 50 mm and minimum widths of 20 mm. One adapter is sufficient if material width does not exceed 50 mm.

### Label unwinder K40

to process label rolls having a core diameter of 40 mm



3.5



3.6

### Adapter 76/100

to pick up label rolls having a core diameter of 100 mm and minimum widths of 20 mm. One adapter is sufficient if material width does not exceed 50 mm.

### Spacers

to process narrow labels provided on liners  $\leq 20$  mm wide, wound on a roll or a reel.

Ribbon protruding on both sides prevents from wrinkling. The label guidance is therefore offset by 7 mm from the middle wall with spacers.

A modified label sensor is included on delivery.

Reel plate wall thickness 1 - 2 mm



3.7



3.16

### Label sensor, modified

Provided for labels requiring a sensor distant up to 26 mm to the locating edge. This sensor cannot be fixed with a screw.

### Margin stop 10

to guide narrow labels provided on a liner 10 - 24 mm wide, wound on a roll (no reels) having a core diameter of 76 mm.

Operate only with a spacer

# Options

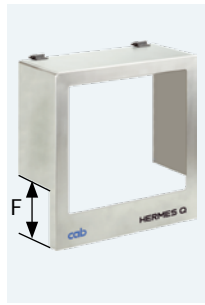

**Cover**

to prevent from contamination and contact  
 Maximum outside diameter for label rolls is 205 mm  
 Assembly in vertical orientation, rotated by ± 90° or horizontally  
 Depth of a pad immersing Dim. F

	Dimension F mm		
	Standard	Optional	on request
HERMES Q2	60	100	up to 120
HERMES Q4/Q4.3	60	100	up to 120
HERMES Q6	25	-	up to 120



**Print head pressure system, reduced force**

Thermal direct printing requires less pressure on a print head.  
 Reduced force results in a decrease of wear. Product life extends.  
 Thermal direct printing only

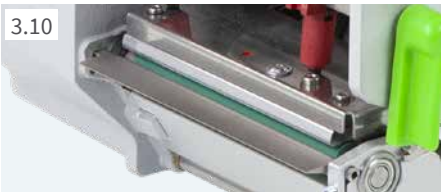

**Extended peel-off plate (+10 mm)**

Recommended  
 - if labels are picked up by a robotic arm,  
 - if readable area is required for scanning,  
 - when installing an antistatic brush



**Print roller DRS**

Silicone coating enables an extra long product life,  
 taken a higher print offset into account



**Antistatic brush**

Electrostatic charge is reduced when plastic labels are printed and peeled off.  
 Operate only with an extended peel-off plate.



**Draw roller ZS**

Made of steel, to avoid tension on a liner tape:  
 - if label height exceeds 150 mm  
 - when peeling off without backfeed  
 - if thick liner materials are processed  
 - when applying labels using a demand module 5114/16



**Interface for plugging an external label sensor**

M12 plug, 5 pins, a-coded  
 Plug-compatible with CEON and other sensors based on PNP and 24 V



**2 port Ethernet switch 10/100 Mbit/s**

to connect another terminal device in a joint network.  
 Signals are looped through.

# Technical data

● typical ■ standard □ option

Label printer		type	HERMES Q2		HERMES Q4.3		HERMES Q4		HERMES Q6.3	
Printing method	Thermal transfer		●	●	●	●	●	●	●	●
	Thermal direct		-	-	●	●	-	-	●	●
Printable resolution	dpi		300	600	200	300	300	600	200	300
Print speed	up to mm/s		300	150	300	300	300	150	250	250
Print width	bis mm		56.9	54.1	104	108.4	105.7	105.7	168	162.6
Direction to which dispense labels			L = to the left, R = to the right							
Print distance to the locating edge	mm		1	1	1	1	1	1	1	1
incl. automatic ribbon saving L/R mm			-	-	2.2/1.6	0/-0.7	1/1	1/1	0.2/0.2	2.9/2.9
<b>UHF RFID</b>										
UHF RFID module			-	-	□	□	□	□	□	□
<b>Materials</b>										
Labels			paper, PET, PE, PP, PI, PVC, PU, acrylate, Tyvec							
		on a roll	●		●		●		●	
		on a reel	●		-		-		-	
Labels <sup>1)</sup>	Width	mm	4 - 58		10 - 114		10 - 114		46 - 174	
	Height	from mm	3		4		4		6	
	Thickness	up to mm	0.60		0.60		0.60		0.60	
Liner tape	Width if operating a roll	mm	24 - 62		24 - 118		24 - 118		50 - 178	
	Width <sup>2)</sup> if operating a reel or a roll	mm	10 - 24		-		10 - 24		-	
	Thickness	mm	0.03 - 0.06		0.03 - 0.06		0.03 - 0.06		0.03 - 0.06	
Roll unwinder	Outside roll diameter	up to mm	205 / 305		205 / 305		205 / 305		205 / 305	
	reel diameter	up to mm	205		-		-		-	
	Core diameter	mm	76							
	Winding		outside or inside							
Roll rewinder	Outside diameter	up to mm	155 / 205							
	Core diameter	mm	76							
Ribbon <sup>3)</sup>	Ink side		outside or inside							
	Roll diameter	up to mm	90							
	Core diameter	mm	25.4							
	Length	up to m	600							
	Width	mm	25 - 67		25 - 114		25 - 114		50 - 170	
Automatic ribbon saving			-		□		□		□	
<b>Printer dimensions and weights</b>										
Width	mm		207		260		260		320	
Height	roll diameters 205 / 305	mm	400 / 430							
Depth	roll diameters 205 / 305	mm	400 / 500							
Weight	roll diameters 205 / 305	approx. kg	15 / 16		16 / 17		16 / 17		20	
<b>Label sensor indicating positions</b>										
Transmissive sensor		detecting	labels, punch marks or print marks, as well as materials ending							
Reflective sensor		bottom reflex detecting	print marks on non-transparent liners, as well as materials ending							
Sensor distance to the locating edge	standard	mm	2 - 12		2 - 60		2 - 60		2 - 60	
	modified	mm	2 - 26							
Material passage		mm	2							
<b>Electronics</b>										
32-bit processor		MHZ	800							
RAM		MB	256							
IFFS memory		MB	50							
Slot to insert a memory card (SDHC, SDXC)			■							
Battery to display date and real time			■							
Data (e.g. serial numbering) preserved if power turns off			■							
<b>Interfaces</b>										
RS232C		1,200 to 230,400 baud / 8 bits	■							
USB 2.0 Hi-Speed to connect a PC			■							
Ethernet		10/100 Mbit/s	LPD, RawIP printing, SOAP web service, OPC UA, WebDAV DHCP, HTTP/HTTPS, FTP/FTPS, TIME, NTP, Zeroconf, SNMP, SMTP, VNC							
2 USB hosts on the control panel, 2 USB hosts on the back of a unit			Service key, USB stick, USB WLAN stick, USB WLAN stick including a rod antenna, keyboard, barcode scanner, warning light, external control panel							
USB host		24 VDC, to connect a peripheral device	■							
Digital I/O interface, 10 inputs / 11 outputs			■							
Interface for plugging an external label sensor			□							
2 port Ethernet switch		10/100 Mbit/s	□							

<sup>1)</sup> Limitations can occur when processing small labels, thin materials or materials using a strong adhesive. Critical applications need testing.

<sup>2)</sup> Spacers attached to the label unwinder and the unit rewinding the liner tape help feeding the ribbon centered above the labels.

<sup>3)</sup> The ribbon must correspond at least to the width of the liner tape.

# Technical data

■ standard □ option

Operating data	
Voltage	100-240 VAC, 50/60 Hz, PFC
Power consumption	standby <10 W / typical 100 W / max. 200 W
Temperature / Operation	+5 - 40°C / 10 - 85 %, not condensing
humidity	Stock 0 - 60°C / 20 - 85 %, not condensing
	Transport -25 - 60°C / 20 - 85 %, not condensing
Approvals	CE, FCC Class A, ICES-3, cULus, CB, RCM Mark, CCC, CoC Mexico, BSMI Mark, KC Mark
Operation panel	
Colored LCD touch display	Screen diagonal " 4,3 Resolution Width x Height px 480 x 272
Setup options	
Print Labels Ribbon Peel off Apply label Interfaces Error	Region: - Language - Country - Keyboard - Time zone Time Display: - Brightness - Power saving mode - Orientation Interpreter
Status bar	
	Data reception WLAN Record data stream Ethernet Pre-warning to a ribbon ending USB slave SD memory card plugged in Time USB memory stick plugged in
Monitoring	
	Ribbon Direction of winding Pinch roller open Pre-warning Peripheral error Material ending Labels Pre-warning Material ending Print head Voltage Temperature open
Test routines	
System diagnostics	on start-up, the print head is also detected
Information display, print test, analysis	Status printout Test grid List of fonts Label profile List of devices List of events WLAN status Monitor mode Record print data on a memory card
Status reports	- Printout of device settings, e.g. durations of printing and hours in operation - Device status request triggered by software command - Display of network errors, missing links, barcode errors, peripheral errors, etc.
Fonts	
Provided internally	5 bitmap fonts: 7 vector fonts: 12 x 12 dots AR Heiti Medium GB-Mono 16 x 16 dots CG Triumvirate Condensed Bold 16 x 32 dots Garuda OCR-A HanWangHeiLight OCR-B Monospace 821 Swiss 721 Regular, Bold
To be stored	TrueType fonts
Character sets	Windows-1250 to -1257 DOS 437, 737, 775, 850, 852, 857, 862, 864, 866, 869 EBCDIC 500 ISO 8859-1 to -10 and -13 to -16 WinOEM 720 UTF-8 MacRoman DEC MCS KOI8-R  Western European Cyrillic Eastern European Greek Chinese, simplified Latin Chinese, traditional Hebrew Thai Arabic

Fonts	
Bitmap fonts	Widths and heights 1 - 3 mm Zoom factors 2 to 10 Orientations 0°, 90°, 180°, 270°
Vector / TrueType fonts	Widths and heights 0,9 - 128 mm Continuous zoom 360° orientation in steps of 1°
Font styles	bold, italic, underlined, outline, inverse - depending from the font type
Character spacing	variable or monospace for fixed spacing
Graphics	
Elements	lines, arrows, rectangles, circles, ellipses - filled or filled with fading
Formats	PCX, IMG, BMP, TIF, MAC, GIF, PNG
Codes	
1D barcodes (linear)	Code 39, Code 93 Interleaved 2/5 Code 39 Full ASCII Ident and routing code Code 128 A, B, C of Deutsche Post EAN 8, 13 Codabar EAN/UCC 128/GS1-128 JAN 8, 13 EAN/UPC Appendix 2 MSI EAN/UPC Appendix 5 Plessey FIM Postnet HIBC RSS 14 UPC A, E, E0
2D and stacked codes	DataMatrix DataMatrix Rectangle Extension QR code Micro QR code GS1 QR code GS1 DataMatrix PDF 417 Micro PDF 417 UPS MaxiCode GS1 DataBar Aztec Codablock F Dotcode RSS 14 truncated, limited, stacked, stacked omni-directional  Heights, modular widths and ratio are variable Orientations 0°, 90°, 180°, 270°  Check digit, plain text printout and start/stop coding are options depending from the code type.
Software	
Label software	cablabel S3 Lite ■ cablabel S3 Viewer ■ cablabel S3 Pro □ cablabel S3 Print □
Running also with	CODESOFT Loftware Spectrum NiceLabel BarTender
Stand-alone operation	■
Windows printer drivers for	Windows 10 Server 2016 Windows 11 Server 2019 Server 2022 ■ Certification WHQL in preparation
Apple printer drivers	Mac OS X 10.6 or any later release ■
Linux printer drivers	CUPS 1.2 or any later release ■
Programming	JScript printer language ■ abc Basic Compiler ■ ZPL II (Datastream be tested in advance) □
Integration	SAP ■ Database Connector ■
Administration	Printer control ■ Configuration on the Intranet / Internet ■

cab uses free and Open Source software in its products.  
For information see [www.cab.de/opensource](http://www.cab.de/opensource)

# cablabel S3 software

## Design, print, administrate

cablabel S3 opens up the full potential of cab devices. Creating a label is the first step. cablabel S3 adapts to requirements easily using a modular design. Plug-ins like the JScript Viewer support native JScript programming, as well as other features. The designer user interface and the JScript code synchronize in real time. The Database Connector and other special features can be integrated, so are barcode verifiers.

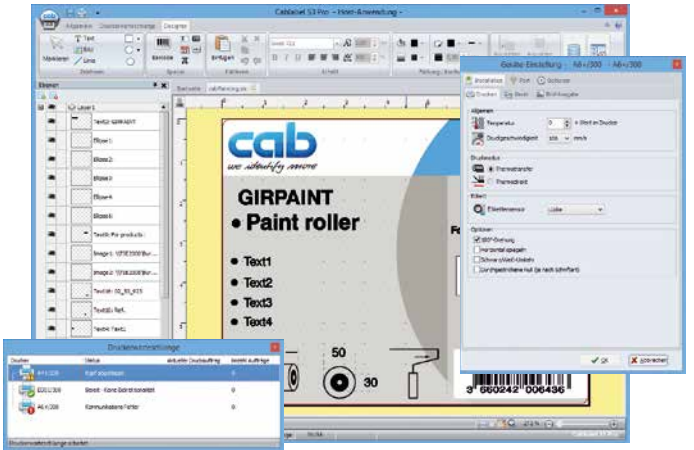

For further information see  
[www.cab.de/en/cablabel](http://www.cab.de/en/cablabel)

## Stand-alone printing

A printer can select and print labels even when the system is disconnected from a host.

Labels are designed using software such as cablabel S3 or a text editor on a PC. Label formats, texts, graphics and data taken from a database are transferred to a memory card, a USB memory stick or the internal IFFS memory.

Only variable data are sent to the printer using a keyboard, a barcode scanner, scale or another host system and/or are recalled from a host by the Database Connector and printed.



## OPC UA

The latest cab printers are ready to interact with machines and components of different manufacturers in industrial plants.

An OPC UA server and a client are part of the firmware.

The server enables a printer be configured and controlled. Dynamic print data can be edited using a defined programming interface.

The integral client enables reading data fields from other machines ready for OPC UA, as well as transferring data to a label. No additional software is needed.



# Printer control

## Drivers



cab provides drivers to control a printer with software other than cablabel S3.



Free download on [www.cab.de/en/support](http://www.cab.de/en/support)



## Programming



### JScript

cab printers embed JScript language. Download free manual on [www.cab.de/en/programming](http://www.cab.de/en/programming)



### abc Basic Compiler

Integral to the firmware, abc in addition to JScript enables advanced programming before data are edited for printout. For example, external printer languages can be replaced without intervening in a print job in progress. Data may be imported as well from other systems such as scales, barcode scanners or PLC.

## Integration



### Printer Vendor Program

cab as a member of this program developed a replace method for controlling cab printers from SAP<sup>1)</sup> R/3 using SAPScript. Only variable data are sent by a host system to a printer. They add on the printer to local images and fonts (IFFS, memory card, etc.).

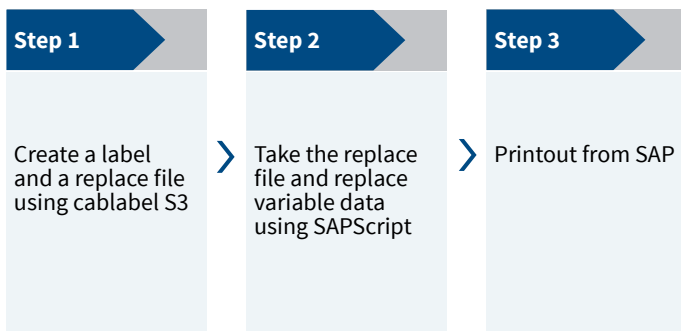

<sup>1)</sup> SAP and all its corresponding logos are trademarks or registered trademarks of SAP SE

# Printer administration



## Configuration on the Intranet / Internet

Integral HTTP / FTP servers enable a printer be controlled or configured, firmware be updated and memory cards be administrated using standard applications such as a web browser or a FTP client.

Administrators and operators on behalf of SNMP / SMTP are notified of states, alerts and errors by email or SNMP datagrams. Time and date are synchronized by a time server.

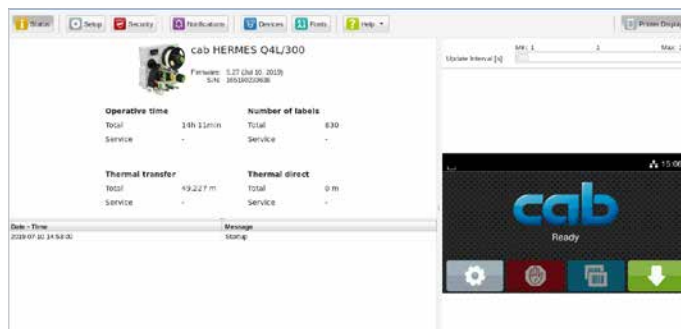

## Database Connector

Printers in a network may access data from a ODBC / OLEDB database and print it on labels. Data can be rewritten to a database while print jobs are in progress.



# Applicators



HERMES Q has been designed for printing and applying labels automatically in production lines. Labels are applied by applicators, using transfer modules to roll, blow or tamp labels on products or packages.

**1 Long product life**

The precise and low-wear linear guide is using a ball bearing chain.

**2 Products of variable heights**

Labels can be applied on different heights using a stroke cylinder. Its standard lengths are 200, 300 and 400 mm. Further lengths can be provided on request.

**3 Protective chassis**

is a standard to protect the cylinder and the guide. It can be provided adapted to the product jig on a labeling workstation.

**4 Highly reliable processes**

Support air and intake air can be defined, so can stroke speed. Sensor control

**5 Label application**

in real time. Small or large labels, 4 to 250 mm high and 4 to 174 mm wide, can be processed using an applicator.



**Pressure-reducing valve**

It reduces the pressure exerted by the stroke cylinder to a product.

**6 Pivoting applicator**

The print mechanics can be accessed quickly and easily in case of maintenance or if materials have to be replaced.



# Applicators and transfer modules

## Overview

Labels are transferred using a  
 Universal pad  
 Tamp-on pad  
 Tamp-on pad, providing a damping layer  
 Tamp-on pad, providing a label stop  
 Blow-on pad  
 Form pad  
 Universal pad, spring-mounted  
 Tamp-on pad, spring-mounted  
 Roll-on pad  
 Corner-wrap pad  
 Demand module  
 Vacuum belt  
 Template

		HERMES Q			Labels are transferred using a														
		2	4	6.3	11	11	12	61	21	88	31	31	41	51	—	—	90		
Applicators		Order code			Page														
Product marking	Swing applicator	3214	3214		18	—	F	F	F	□	—	—	—	—	—	—	—		
	Stroke applicator	4114	4114		19/20	—	F	F	F	□	□	—	—	—	—	—	—		
				4116	19/20	—	F	F	F	—	□	—	—	—	—	—	—		
	Stroke turn applicator	4214	4214		21	—	F	F	F	□	—	—	—	—	—	—	—		
	Stroke applicator	4414	4414		22	—	F	F	F	—	—	—	—	—	—	—	—		
	Swing stroke applicator	4514	4514		23	—	—	—	—	□	—	—	—	—	—	—	—		
Flag applicator		4712		24	—	—	—	—	—	□	—	—	—	—	—	—			
Package marking	Front side applicator		3014		25	—	□	—	—	□	—	—	□	—	—	—			
				3016	25	—	□	—	—	—	—	—	□	—	—	—			
	Stroke applicator		4014		26/27	□	F	—	—	□	—	□	□	□	—	—			
				4016	26/27	—	□	—	—	—	—	—	□	□	—	—			
	Stroke blow applicator		4614		28	—	—	—	—	□	—	—	—	—	—	—			
	Demand module	5112	5114	5116	29	—	—	—	—	—	—	—	—	—	□	—			
	Vacuum belt applicator		5314	5316	30	—	—	—	—	—	—	—	—	—	—	□			
			5414	5416	31	—	—	—	—	—	—	—	—	—	—	□			
Air jet box		6114		32	—	—	—	—	—	—	—	—	—	—	□				

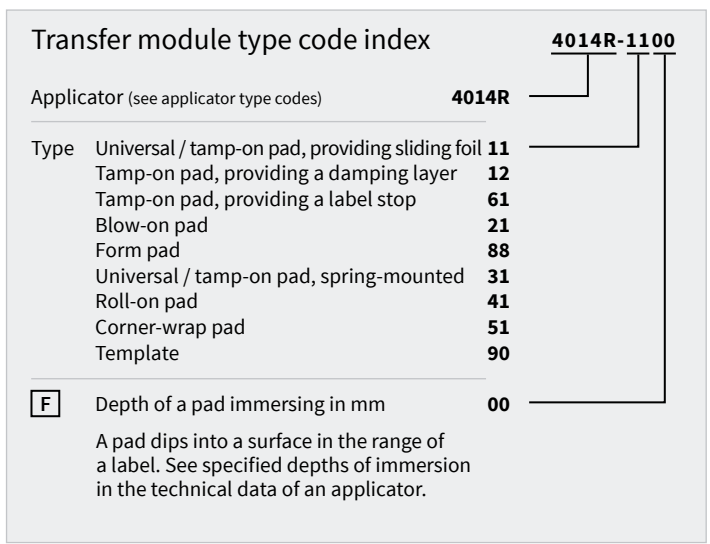
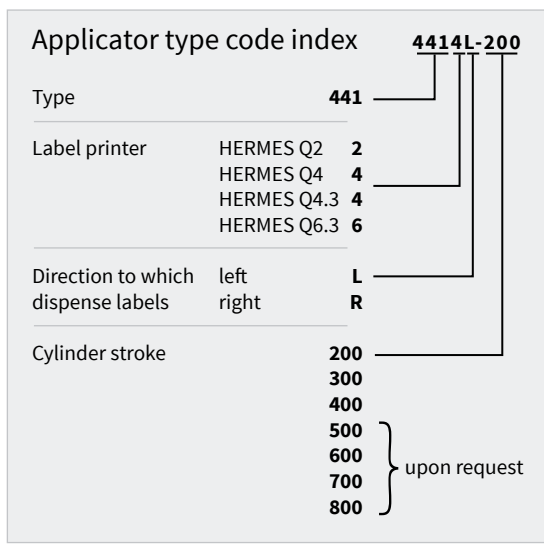

# Product marking

## Swing applicator 3214

Labels very small or midsized can be applied in real time, preferably from the side.

The pad locates in front of the peel-off plate. It picks up a label while it is being printed. A rotary cylinder pivots into position. The label is transferred to a product by a stroke cylinder. Rotary angles and linear hubs are adjustable.



4.1



### Accessories

5.13 **Blow tube**

5.14 **Unit to regulate compressed air**



**Tamp-on pad**

Labels are precisely tamped on plane surfaces. Recessed levels are possible as well.

**Tamp-on pad, providing a damping layer**

When applying labels to hard surfaces, the noise level is reduced. It benefits also in cases of rough structures or little unevenness.

**Tamp-on pad, providing a label stop**

It enables small labels be applied exactly on spot to a product.

**Blow-on pad**

It benefits when labels have to be applied to sensitive surfaces or products in motion. Labels are blown on by a blast of air. Stroke cylinder adjustment enables bridging distances of 5 to 10 mm to the surface of a product.

		<b>Tamp-on pad</b>	<b>Tamp-on pad, providing a damping layer</b>	<b>Tamp-on pad, providing a label stop</b>	<b>Blow-on pad</b>
		<b>3214 L/R 11 F</b>	<b>3214 L/R 12 F</b>	<b>3214 L/R 61 F</b>	<b>3214 L/R 2100</b>
<b>Technical data</b>					
Label widths operating a HERMES Q2	mm	4 - 58	10 - 58	10 - 58	10 - 58
HERMES Q4/Q4.3	mm	10 - 114	10 - 114	10 - 114	10 - 80
Label heights operating a HERMES Q2	mm	5 - 80	8 - 80	5 - 80	10 - 80
HERMES Q4/Q4.3	mm	8 - 80	8 - 80	8 - 80	10 - 80
State of a product at the moment a label is applied	at rest / in motion			■	■
Label application					from the side
Product heights	uniform			■	
Distance of a product to the peel-off plate	mm			250 - 280	
Linear guidance, horizontal	mm			5 - 30	
Pivot angles				45° - 95°	
Depth of a pad immersing F	up to mm	30	30	30	-
Weight of applicator	packaging excluded kg			4.5	
Consumption of power	W max.			15	
Compressed air	bar			4.5	
Cycle rate <sup>1)</sup>	labels/min approx.			20	

<sup>1)</sup> calculated using labels 40 mm high and a print speed of 100 mm/s

# Product marking

## Stroke applicators 4114, 4116

Labels very small or midsized can be applied in real time from all sides.

The pad locates in front of the peel-off plate. It picks up a label while it is being printed. Powered by a short stroke cylinder, the pad is brought into position in horizontal direction. The label is transferred to a product by a stroke cylinder. The length of the stroke cylinder defines the maximum distance of a product to the peel-off plate.



### Accessories

#### 5.13 Blow tube

#### 5.14 Unit to regulate compressed air

#### 5.17 Pressure-reducing valve



4.2



### Tamp-on pad

Labels are precisely tamped on plane surfaces. Recessed levels are possible as well.

### Tamp-on pad, providing a damping layer

When applying labels to hard surfaces, the noise level is reduced. It benefits also in cases of rough structures or little unevenness.

### Tamp-on pad, providing a label stop

It enables small labels be applied exactly on spot to a product.

### Blow-on pad

It benefits when labels have to be applied to sensitive surfaces or products in motion. Labels are blown on by a blast of air. Stroke cylinder adjustment enables bridging distances of 5 to 10 mm to the surface of a product.

			Tamp-on pad	Tamp-on pad, providing a damping layer	Tamp-on pad, providing a label stop	Blow-on pad
Technical data			4114, 4116 L/R 11 F	4114, 4116 L/R 12 F	4114, 4116 L/R 61 F	4114 L/R 2100
Label widths operating a	HERMES Q2	mm	4-58	10-58	10-58	10-58
	HERMES Q4/Q4.3	mm	10-114	10-114	10-114	10-114
	HERMES Q6.3	mm	50-174	50-174	50-174	-
Label heights operating a	HERMES Q2	mm	4-80	8-80	4-80	10-80
	HERMES Q4/Q4.3	mm	8-80	8-80	8-80	10-80
	HERMES Q6.3	mm	8-80	8-80	8-80	-
State of a product	at rest				■	
at the moment a label is applied	in motion		-	-	-	■
Label applications			from the top, from below, from the side			
Product heights	uniform		-	-	-	■
	variable		■	■	■	-
Short stroke cylinder, horizontal	mm		10			
Distance of a product to the bottom of the unit using a cylinder stroke of	200	up to mm	135	135	135	140
	300	up to mm	235	235	235	240
	400	up to mm	335	335	335	340
Depth of a pad immersing F <sup>1)</sup>	up to mm		110	110	110	-
Weight of applicator using a cylinder stroke of	200	packaging excluded kg	4114		4116	
	300	packaging excluded kg	5		5	
	400	packaging excluded kg	5.5		6	
Consumption of power	W max.		15			
Compressed air	bar		4.5			
Cycle rate <sup>2)</sup>	labels/min approx.		30			

<sup>1)</sup> On the cover HERMES Q2/Q4/Q4.3 cut-out dimension F standard 60 mm, optional 100 mm, on request up to 110 mm  
On the cover HERMES Q6.3 cut-out dimension F standard 25 mm, on request up to 110 mm

<sup>2)</sup> calculated using a stroke of 100 mm below the unit, labels 40 mm high, a print speed of 100 mm/s

# Product marking

## Stroke applicators 4114, 4116

Labels very small or midsized can be applied in real time from all sides.

The pad locates in front of the peel-off plate. It picks up a label while it is being printed. Powered by a short stroke cylinder, the pad is brought into position in horizontal direction. The label is transferred to a product by a stroke cylinder. The length of the stroke cylinder defines the maximum distance of a product to the peel-off plate.



### Accessories

- 5.13 **Blow tube**
- 5.14 **Unit to regulate compressed air**
- 5.17 **Pressure-reducing valve**



### Form pad

Labels are precisely applied to cylindric objects, inclined or curved surfaces. Curved form pads prevent from blistering on very smooth and plane surfaces. 200° maximum label wrapping on cylindric objects

Technical data		Form pad		
		4114, 4116 L/R 8800		
Label widths operating a HERMES Q2	mm	10 - 58		
HERMES Q4/Q4.3	mm	10 - 114		
HERMES Q6.3	mm	50 - 174		
Label heights	mm	8 - 80		
State of a product at the moment a label is applied	at rest	■		
Label applications		from the top, from below, from the side		
Product heights	variable	■		
Short stroke cylinder, horizontal	mm	10		
Distance of a product to the bottom of the unit using a cylinder stroke of	200	up to mm	135	
	300	up to mm	235	
	400	up to mm	335	
Weight of applicator using a cylinder stroke of	packaging excluded kg	<b>4114</b>	<b>4116</b>	
		200	5	5
		300	5.5	6
400	7	7.5		
Consumption of power	W max.	15		
Compressed air	bar	4.5		
Cycle rate <sup>1)</sup>	labels/min approx.	20		

<sup>1)</sup> calculated using a stroke of 100 mm below the unit, labels 40 mm high, a print speed of 100 mm/s  
If the height of the form pad exceeds 25 mm, the cover of HERMES Q must be adapted.

# Product marking

## Stroke turn applicator 4214

Labels very small or midsized can be applied in real time from all sides whenever the unit is difficult to install.

The pad locates in front of the peel-off plate. It picks up a label while it is being printed. Powered by a rotary cylinder, the pad pivots into position by at most 180° in horizontal direction. The label is transferred to a product by a stroke cylinder. The length of the stroke cylinder defines the maximum distance of a product to the peel-off plate.



### Accessories

#### 5.13 Blow tube

#### 5.14 Unit to regulate compressed air

#### 5.17 Pressure-reducing valve

4.3



#### Tamp-on pad

Labels are precisely tamped on plane surfaces. Recessed levels are possible as well.

#### Tamp-on pad, providing a damping layer

When applying labels to hard surfaces, the noise level is reduced. It benefits also in cases of rough structures or little unevenness.

#### Tamp-on pad, providing a label stop

It enables small labels be applied exactly on spot to a product.

#### Blow-on pad

It benefits when labels have to be applied to sensitive surfaces or products in motion. Labels are blown on by a blast of air. Stroke cylinder adjustment enables bridging distances of 5 to 10 mm to the surface of a product.

	Tamp-on pad	Tamp-on pad, providing a damping layer	Tamp-on pad, providing a label stop	Blow-on pad
Technical data	4214 L/R 11 F	4214 L/R 12 F	4214 L/R 61 F	4214 L/R 2100
Label widths operating a HERMES Q2	mm	4 - 58	10 - 58	10 - 58
HERMES Q4/Q4.3	mm		10 - 80	
Label heights operating a HERMES Q2	mm	4 - 40	8 - 40	4 - 40
HERMES Q4/Q4.3	mm	8 - 40	8 - 40	8 - 40
State of a product at the moment a label is applied	at rest		■	
	in motion	-	-	■
Label applications		from the top, from below, from the side		
Product heights	uniform	-	-	■
	variable	■	■	-
Rotary angle, horizontal	90°, 0°		■	
	180° if labels are no more than 15 mm high			
Distance of a product to the bottom of the unit using a cylinder stroke of 200	up to mm	135	135	135
	300	235	235	240
	400	335	335	340
Depth of a pad immersing F <sup>1)</sup>	up to mm	65	65	65
Weight of applicator using a cylinder stroke of 200	packaging excluded kg		5.5	
	300		5.5	
	400		7.5	
Consumption of power	W max.		15	
Compressed air	bar		4.5	
Cycle rate <sup>2)</sup>	labels/min approx.		20	

<sup>1)</sup> On the cover HERMES Q2/Q4/Q4.3 cut-out dimension F standard 60 mm, optional 100 mm

<sup>2)</sup> calculated using a stroke of 100 mm below the unit, labels 40 mm high, a print speed of 100 mm/s

# Product marking

## Stroke applicator 4414

Labels very small or midsized can be applied in real time from all sides. Positions to which labels shall be applied can be adjusted in directions x and y.

The pad locates in front of the peel-off plate. It picks up a label while it is being printed. Powered by two short stroke cylinders, the pad is brought into position. The label is transferred to a product by a stroke cylinder. The length of the stroke cylinder defines the maximum distance of a product to the peel-off plate.



### Accessories

- 5.13 **Blow tube**
- 5.14 **Unit to regulate compressed air**
- 5.17 **Pressure-reducing valve**



### Tamp-on pad

Labels are precisely tamped on plane surfaces. Recessed levels are possible as well.

### Tamp-on pad, providing a damping layer

When applying labels to hard surfaces, the noise level is reduced. It benefits also in cases of rough structures or little unevenness.

### Tamp-on pad, providing a label stop

It enables small labels be applied exactly on spot to a product.

	Tamp-on pad	Tamp-on pad, providing a damping layer	Tamp-on pad, providing a label stop
Technical data	4414 L/R 11 F	4414 L/R 12 F	4414 L/R 61 F
Label widths operating a HERMES Q2	mm	4 - 58	10 - 58
HERMES Q4/Q4.3	mm		10 - 114
Label heights operating a HERMES Q2	mm	4 - 80	8 - 80
HERMES Q4/Q4.3	mm		8 - 80
State of a product at the moment a label is applied	at rest	■	
Label applications		from the top, from below, from the side	
Product heights	variable	■	
Short stroke cylinders, horizontal	direction x mm	3 - 7	
	direction y mm	11 - 15	
Distance of a product to the bottom of the unit using a cylinder stroke of 200	up to mm	135	
	300 up to mm	235	
	400 up to mm	335	
Depth of a pad immersing F <sup>1)</sup>	up to mm	90	
Weight of applicator using a cylinder stroke of 200	packaging excluded kg	5.5	
	300 packaging excluded kg	5.5	
	400 packaging excluded kg	6	
Consumption of power	W max.	15	
Compressed air	bar	4.5	
Cycle rate <sup>2)</sup>	labels/min approx.	25	

<sup>1)</sup> On the cover HERMES Q2/Q4/Q4.3 cut-out dimension F standard 60 mm, optional 100 mm

<sup>2)</sup> calculated using a stroke of 100 mm below the unit, labels 40 mm high, a print speed of 100 mm/s

# Product marking

## Swing stroke applicator 4514

Labels can be applied in real time from all sides on inner surfaces of profiles and pipes. Stroke cylinder adjustment enables labels be transferred exactly to their dedicated spots.

The pad locates in front of the peel-off plate. It picks up a label while it is being printed. Powered by a rotary cylinder, the pad pivots to the level on which the label shall be applied. The label is moved to the point of transfer by a stroke cylinder.



### Accessories

#### 5.13 Blow tube

#### 5.14 Unit to regulate compressed air

4.5



### Blow-on pad

Labels are blown on a product surface by a blast of air, bridging a distance of 5 to 10 mm.

Technical data		Blow-on pad 4514 L/R 2100
Label widths operating a HERMES Q2	mm	10 - 58
HERMES Q4/Q4.3	mm	10 - 80
Label heights	mm	10 - 60
State of a product at the moment a label is applied	at rest	■
Label applications		from the top, from below, from the side
Product heights	uniform	■
Pivot angle, vertical		120°
Distance between the bottom of the unit and the upper label ending using a cylinder stroke of 200	up to mm	150 <sup>2)</sup>
300	up to mm	250 <sup>2)</sup>
400	up to mm	350 <sup>2)</sup>
Weight of applicator using a cylinder stroke of 200	packaging excluded kg	6
300	packaging excluded kg	6.5
400	packaging excluded kg	7
Consumption of power	W max.	15
Compressed air	bar	4.5
Cycle rate <sup>1)</sup>	labels/min approx.	20

<sup>1)</sup> calculated using a stroke of 100 mm below the unit, labels 40 mm high, a print speed of 100 mm/s

<sup>2)</sup> depending from the height of a label

# Product marking

## Flag applicator 4712

Labels can be applied in real time from all sides precisely on round materials such as cables, hoses or pipes.

The pad locates in front of the peel-off plate. It picks up a label while it is being printed. The label is transferred to the spot of application by a stroke cylinder. A further cylinder guides the material all around the material using cam control. First, both endings of a label are stuck together. Then the label is tamped to the round material. The length of the stroke cylinder defines the maximum distance of a product to the peel-off plate.

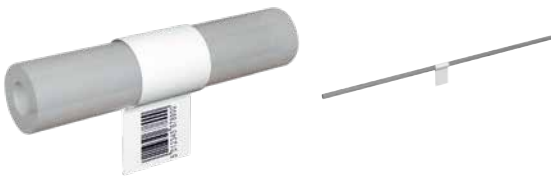

## Accessories

### 5.13 Blow tube

### 5.14 Unit to regulate compressed air

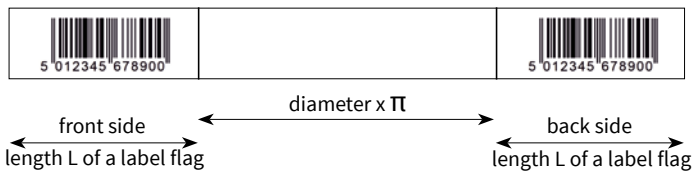

4.6

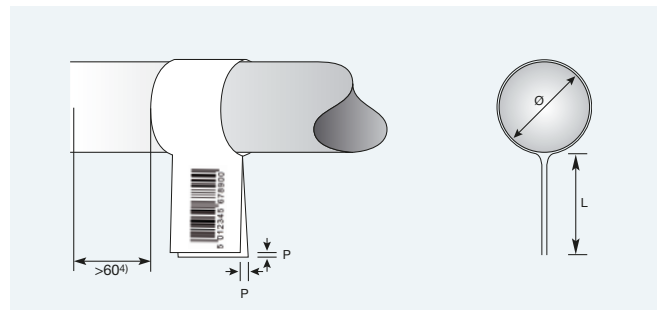

Technical data		Form pad
		4712 L 300
Label widths operating a HERMES Q4L/Q4.3L	mm	50 <sup>1)</sup> - 100
Label heights	mm	10 - 50
Diameter	mm	3 - 16
State of a product at the moment a label is applied	at rest	■
Label applications		from the top, from below, from the side rotated vertically: 0 - 180° clockwise (request in case of other rotations)
Product heights	uniform	■
Distance of a product to the bottom of the unit using a cylinder stroke of 300	at least mm up to mm	70 260
Depth of pliers immersing	mm	55
Offset P	up to mm	1.0 <sup>2)</sup>
Weight of applicator	packaging excluded kg	8
Consumption of power	W max.	15
Compressed air	bar	4.5
Cycle rate, printing and applying only <sup>3)</sup> labels/min approx.		15

<sup>1)</sup> Processing labels 50 to 58 mm wide requires a spacer.

<sup>2)</sup> depending from the quality of a label

<sup>3)</sup> calculated using a print speed of 100 mm/s

<sup>4)</sup> Flag on product requires >60 mm clearance on one side without components, bend or step



# Package marking

## Front side applicators 3014, 3016

Labels can be applied in real time from the top or the side to packages in motion. Front sides or back sides of a package are preferred.

The pad locates in front of the peel-off plate. It picks up a label while it is being printed. The label is transferred to a product with the help of a rotary cylinder. The package is detected by a sensor and the pivot arm with the pad returned to its initial position.

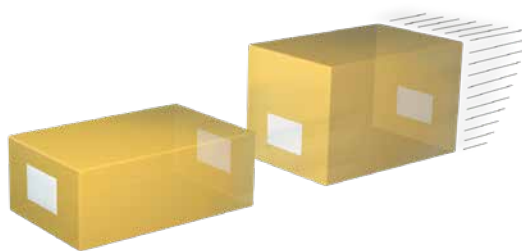

## Accessories

### 5.13 Blow tube

### 5.14 Unit to regulate compressed air

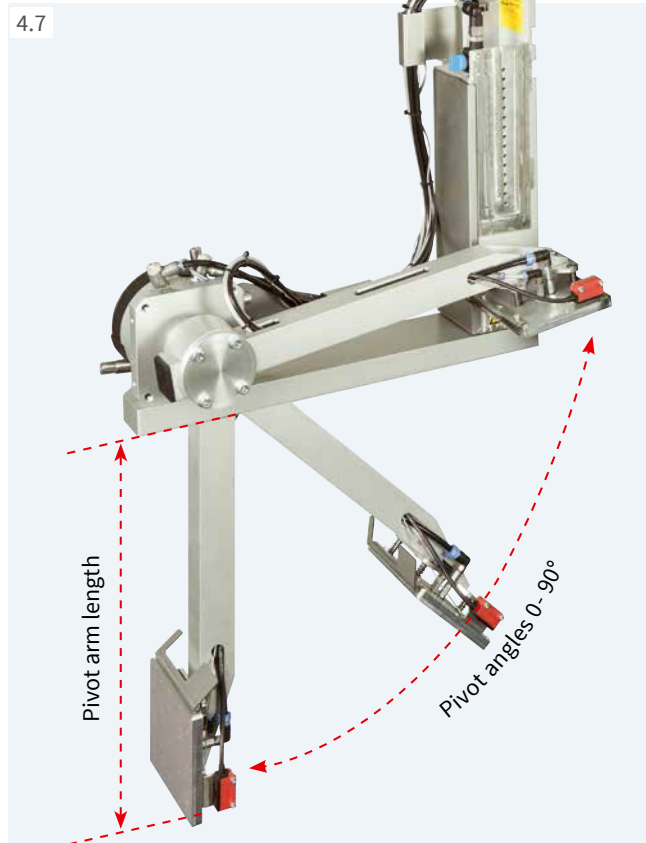

### Tamp-on pad

Labels are precisely tamped on plane surfaces. Recessed levels are possible as well.

### Tamp-on pad, spring-mounted

Labels can be applied to surfaces inclined by a maximum of 15°. Heights within the area of a label may vary by 10 mm at most.

### Blow-on pad

Labels are blown on a package surface by a blast of air, bridging a distance of 5 to 10 mm.

Technical data	Tamp-on pad		Tamp-on pad, spring-mounted	Blow-on pad
	3014, 3016 L/R 1100		3014, 3016 L/R 3100	3014 L/R 2100
Label widths operating a HERMES Q4/Q4.3	mm	25 - 114	80 - 114	25 - 114
HERMES Q6.3	mm	25 - 174	80 - 174	-
Label heights operating a HERMES Q4/Q4.3	mm	8 - 250	80 - 250	10 - 100
HERMES Q6.3	mm	25 - 250	80 - 250	25 - 100
State of a package at the moment a label is applied	at rest	■		
	in motion	■		
Label applications		from the top, from the side, from the front, from the back		
Package heights	variable	■		
Pivot arm lengths <sup>1)</sup>	mm	200 / 300 / 400		
Pivot angles		0 - 90°		
Weight of applicator using a pivot arm of 200		<b>3014</b>		<b>3016</b>
packaging excluded	kg	9		9.5
300	kg	9.5		10
400	kg	10.5		11
Consumption of power	W max.	15		
Compressed air	bar	4.5		
Cycle rate <sup>2)</sup>	labels/min approx.	15		

<sup>1)</sup> Pivot arm length defines the spot of a label (lower margin) to be reached at 90° below a HERMES Q footprint.

<sup>2)</sup> calculated using a pivot arm 200 mm long, labels 100 mm high, a print speed of 100 mm/s

# Package marking

## Stroke applicators 4014, 4016

Labels can be applied in real time from all sides to packages. The type of pad defines whether a package has to be at rest or can be in motion at the time a label is applied.

The pad locates in front of the peel-off plate. It picks up a label while it is being printed. The label is transferred to a package with the help of a stroke cylinder. The package is detected by a sensor and the pad returned to its initial position. The length of the stroke cylinder defines the maximum distance of a package to the peel-off plate.



## Accessories

### 5.13 Blow tube

### 5.14 Unit to regulate compressed air

### 5.17 Pressure-reducing valve

4.8



### Tamp-on pad

Labels are precisely tamped on plane surfaces. Recessed levels are possible as well.

### Universal pad

Labels can be tamped on plane surfaces. Drilled holes are provided in gaps of 5 mm to suck a label. The holes are covered by a sliding foil, but can be opened according to the size of a label using a punching tool. Delivery includes two extra foils.

### Tamp-on pad, spring-mounted

Labels can be applied to surfaces inclined by a maximum of 15°. Heights within the area of a label may vary by 10 mm at most.

### Universal pad, spring-mounted

Labels can be applied to surfaces inclined by a maximum of 15°. Heights in the area of a label may vary by 10 mm at most. To suck a label, drilled holes are provided in gaps of 5 mm and covered by a sliding foil. Delivery includes two extra foils.

		Tamp-on pad	Universal pad	Tamp-on pad, spring-mounted	Universal pad, spring-mounted
Technical data		4014, 4016 L/R 11 F	4014 L/R 1100	4014, 4016 L/R 3100	4014 L/R 3100
Label widths operating a HERMES Q4/Q4.3	mm	20 - 114	75 / 90	80 - 114	116 / 116
HERMES Q6.3	mm	50 - 174	-	80 - 174	-
Label heights operating a HERMES Q4/Q4.3	mm	20 - 210	60 / 90	80 - 210	102 / 152
HERMES Q6.3	mm	25 - 210	-	80 - 210	-
State of a package at the moment a label is applied	at rest	■			
Label applications		from the top, from below, from the side			
Package heights	variable	■			
Distance of a package to the bottom of the unit using a cylinder stroke of					
200	up to mm	135	135	130	130
300	up to mm	235	235	230	230
400	up to mm	335	335	330	330
Depth of a pad immersing F <sup>1)</sup>	up to mm	120	-	-	-
Weight of applicator using a cylinder stroke of		<b>4014</b>		<b>4016</b>	
200	packaging excluded kg	5		5	
300	packaging excluded kg	5		5.5	
400	packaging excluded kg	7		7.5	
Consumption of power	W max.				15
Compressed air	bar				4.5
Cycle rate <sup>2)</sup>	labels/min approx.				25

<sup>1)</sup> On the cover HERMES Q2/Q4/Q4.3 cut-out dimension F standard 60 mm, optional 100 mm, on request up to 120 mm  
On the cover HERMES Q6.3 cut-out dimension F standard 25 mm, on request up to 120 mm

<sup>2)</sup> calculated using a stroke of 100 mm below the unit, labels 40 mm high, a print speed of 100 mm/s

# Package marking

## Stroke applicators 4014, 4016

Labels can be applied in real time from all sides to packages. The type of pad defines whether a package has to be at rest or can be in motion at the time a label is applied.

The pad locates in front of the peel-off plate. It picks up a label while it is being printed. The label is transferred to a package with the help of a stroke cylinder. The package is detected by a sensor and the pad returned to its initial position. The length of the stroke cylinder defines the maximum distance of a package to the peel-off plate.

4.8



### Accessories

- 5.13 **Blow tube**
- 5.14 **Unit to regulate compressed air**
- 5.17 **Pressure-reducing valve**



#### Blow-on pad

It benefits when labels have to be applied to sensitive surfaces or packages in motion. Labels are blown on by a blast of air. Stroke cylinder adjustment enables bridging distances of 5 to 10 mm to the surface of a package.

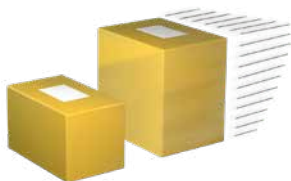

#### Roll-on pad

Labels are rolled on plane surfaces while these packages are in motion.



#### Corner-wrap pad

Labels are applied to a package on two sides adjacent to one another. One half of a label is applied to the top of a package. Then the other half of the label is rolled on.

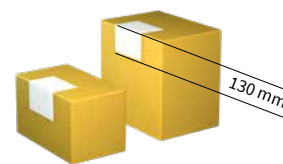

Technical data			Blow-on pad	Roll-on pad	Corner-wrap pad
			4014 L/R 2100	4014, 4016 L/R 4100	4014 L/R 5100
Label widths operating a	HERMES Q4/Q4.3	mm	20 - 114	25 - 114	20 - 114
	HERMES Q6.3	mm	provided on request	50 - 174	-
Label heights operating a	HERMES Q4/Q4.3	mm	20 - 100	80 - 250	60 - 210
	HERMES Q6.3	mm	provided on request	80 - 250	-
State of a package	at rest		■	-	■
at the moment a label is applied	in motion		■	■	-
Label applications	from the top			■	
	from below		■		-
	from the side		■	■	-
Package heights	uniform		■	-	-
	variable		-	■	■
Distance of a package to the bottom of the unit using a cylinder stroke of	200	up to mm	140	160	100
	300	up to mm	240	260	200
	400	up to mm	340	360	300
Weight of applicator	packaging excluded kg		see page 26		
Consumption of power	W max.		15		
Compressed air	bar		4.5		
Cycle rate <sup>1)</sup>	labels/min approx.		25	20	20

<sup>1)</sup> calculated using a stroke of 100 mm below the unit, labels 100 mm high, a print speed of 100 mm/s

# Package marking

## Stroke blow applicator 4614

Labels can be applied in real time from all sides on packages of various heights in motion.

The pad locates in front of the peel-off plate. It picks up a label while it is being printed. Powered by a stroke cylinder and detected by a sensor, the pad moves to a spot approx. 10 mm above a package. The length of the stroke cylinder defines the maximum difference in terms of package heights.

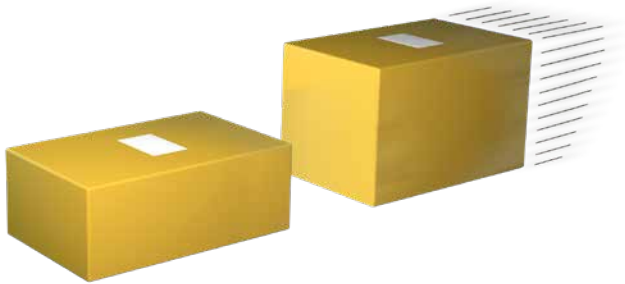

### Accessories

- 5.13 **Blow tube**
- 5.14 **Unit to regulate compressed air**



**Blow-on pad**  
Labels are blown on a package surface by a blast of air, bridging a distance of 5 to 10 mm.

Technical data		Blow-on pad
		4614 L/R 2100
Label widths operating a HERMES Q4/Q4.3	mm	20 - 114
HERMES Q6.3	mm	provided on request
Label heights operating a HERMES Q4/Q4.3	mm	20 - 100
HERMES Q6.3	mm	provided on request
State of a package at the moment a label is applied	at rest in motion	■ ■
Label applications		from the top, from below, from the side
Package heights	uniform variable	■ ■
Distance of a package to the bottom of the unit using a cylinder stroke of		
200	up to mm	140
300	up to mm	240
400	up to mm	340
Weight of applicator using a cylinder stroke of		
200	packaging excluded kg	not specified
300	packaging excluded kg	5.5
400	packaging excluded kg	6.5
Consumption of power	W max.	15
Compressed air	bar	4.5
Cycle rate <sup>1)</sup>	labels/min approx.	25

<sup>1)</sup> calculated using a stroke of 100 mm below the unit, labels 100 mm high, a print speed of 100 mm/s

# Package marking

## Demand modules 5112, 5114, 5116

Series of labels can be applied from all sides to packages in motion. The position to which apply a label can be defined on the dispenser tongue using a guide roller.

While a label is applied, the next one is printed simultaneously. Make sure the speed of the conveyor belt corresponds to the print speed.

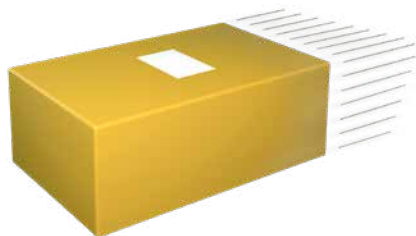

Demand module		5112 L/R	5114 L/R	5116 L/R
Label widths operating a HERMES Q2	mm	10 - 58	-	-
HERMES Q4/Q4.3	mm	-	25 - 114	-
HERMES Q6.3	mm	-	-	46 - 174
Label heights	mm	10 - 250		25 - 250
Distance of the print line to the peel-off plate	mm		400 - 600	
State of a package at the moment a label is applied	in motion		■	
Label applications		from the top, from below, from the side		
Package heights	uniform		■	
Distance of a package to the bottom of the unit	mm		80	
Package speeds	mm/s	must correspond to the print speed / 50 - 250 in steps of 25		
Weight of module	packaging excluded kg	not specified	3	7
Consumption of power	W max.	not specified		
Cycle rate <sup>1)</sup>	labels/min approx.	60		

<sup>1)</sup> calculated using labels 100 mm high and a print speed of 100 mm/s

# Package marking

## Vacuum belt applicators 5314, 5316

Labels can be applied in real time from all sides on plane surfaces to packages in motion.

The applicator locates in front of the peel-off plate. Printed labels are conveyed by a vacuum belt to the point of transfer to a package. Applying a label is triggered by an external signal.

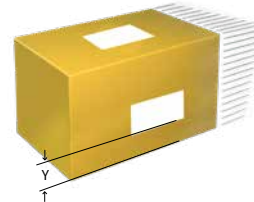
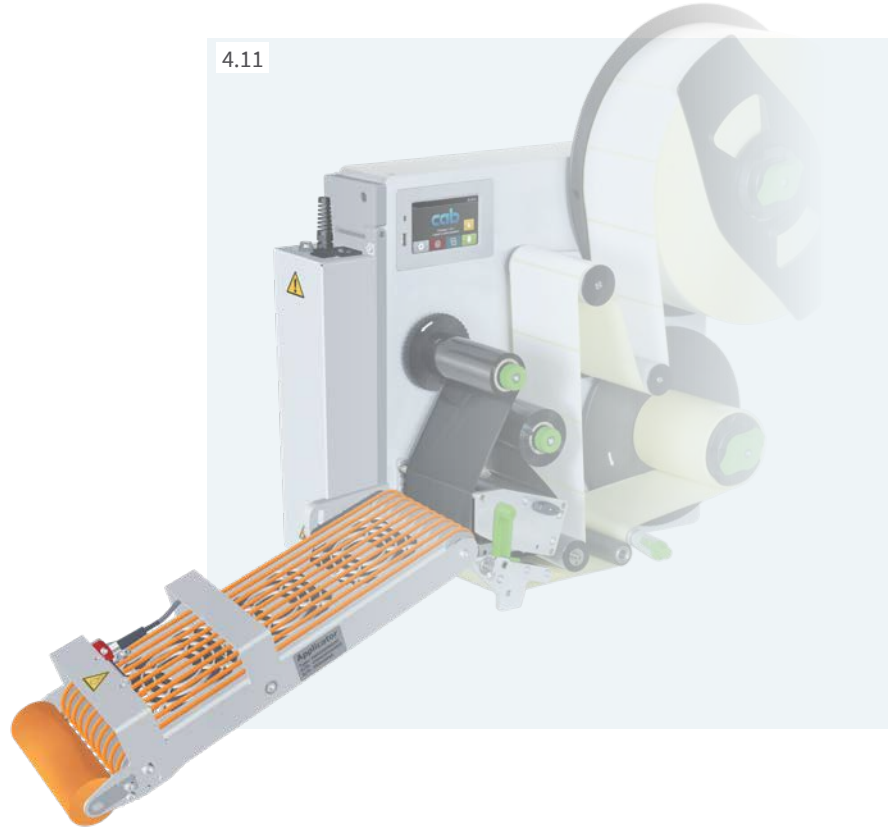

Vacuum belt applicator		5314-3	5316-3
Label applications		on plane surfaces	
Directions to which dispense labels		left and right	
Label widths operating a HERMES Q4/Q4.3	mm	20 - 114	-
HERMES Q6.3	mm	-	46 - 174
Label heights	mm	60 - 356	60 - 356
State of a package at the moment a label is applied	in motion	■	
Label applications		from the top, from below, from the side	
Package heights	uniform	■	
Package speeds	up to m/s	0.5	
Gap between packages	at least m	0.5	
Vacuum belt speed <sup>1)</sup>	mm/s	100 - 500	
Weight of applicator	packaging excluded kg	7	8
Consumption of power	W max.	90	
Cycle rate <sup>2)</sup>	labels/min up to	30	
Distance of a label to the conveyor belt, when applying from the side	mm	Y = 20	

<sup>1)</sup> The speed of a package must be at least as high as the speed of the vacuum belt.

<sup>2)</sup> calculated using labels 100 mm high and a print speed of 250 mm/s

# Package marking

## Vacuum belt applicators 5414, 5416

Labels can be applied in real time from all sides on cylindric surfaces, or corner-wrap to packages in motion.

The applicator locates in front of the peel-off plate. Printed labels are conveyed by a vacuum belt to the point of transfer to a package. Applying a label is triggered by an external signal.



Vacuum belt applicator		5414-3	5416-3
Label applications		on cylindric surfaces and corner-wrap	
Directions to which dispense labels		left and right	
Label widths operating a HERMES Q4/Q4.3	mm	20 - 114	-
HERMES Q6.3	mm	-	46 - 174
Label heights	mm	80 - 356	80 - 356
State of a package at the moment a label is applied	in motion	■	
Label applications		from the top, from the side	
Package heights	uniform	■	
	variable	■	
Package speeds	up to m/s	0.3	
Gap between packages	at least m	0.5	
Steadiness identified at the point a label is transferred		F <sup>1)</sup> = 30 N	
Corner-wrap label applications	up to mm	X = 160	
Vacuum belt speed <sup>2)</sup>	mm/s	100 - 300	
Weight of applicator	packaging excluded kg	7	8.5
Consumption of power	W max.	90	
Cycle rate <sup>3)</sup>	labels/min up to	15	
Distance of a label to the conveyor belt, when applying from the side	mm	Y = 20	

<sup>1)</sup> F = force required to make the vacuum belt pivot

<sup>2)</sup> The speed of a package must be at least as high as the speed of the vacuum belt.

<sup>3)</sup> calculated using labels 100 mm high and a print speed of 250 mm/s

# Package marking

## Air jet box 6114

Labels can be applied to packages in motion or at rest. Each label is sucked by a fan and blown off by a powerful blast of air coming through aligned nozzles. Depending from the size of a label, a maximum distance of 200 mm can be bridged between a package and the peel-off plate.

### Accessories

- 5.13 **Blow tube**
- 5.16 **Unit to regulate compressed air, providing a shut-off valve** to vent a hose line subsequent to the unit; provided in a left-hand or right-hand design



### 1 Template

to cover all the holes sucking or blowing off air outside a label

By holes pre-scored on an 8 x 8 mm pattern, a template can be adapted easily to the size of a label. By sliding in a template between the suction block and rails, the surface outside a label is covered. Scope of delivery includes five templates.

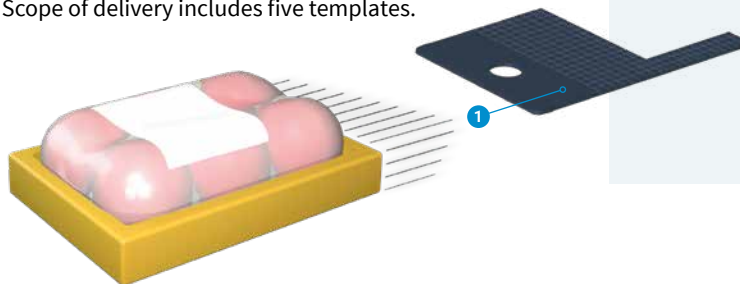

4.13



Air jet box		6114 L/R
Label widths operating a HERMES Q4/Q4.3	mm	50-114 smaller sizes can be provided on request
Label heights	mm	50-125 smaller sizes can be provided on request
State of a package at the moment a label is applied	at rest in motion	■ ■
Label application		from the top, from below, from the side
Package heights	variable	■
Distance of a package to the peel-off plate up to	mm	200
Weight of air jet box	packaging excluded kg	4
Consumption of power	W max.	90
Compressed air	bar	4.5 - 6
Cycle rate <sup>1)</sup>	labels/min up to	100

<sup>1)</sup> calculated using labels 50 mm high, a print speed of 250 mm/s, a blast of air lasting 100 ms, with packages located 100 mm to the peel-off plate.



## Accessories and options provided for applicators

■ standard □ option

Pos.	Designation	4.1 3214	4.2 4114/16	4.3 4214	4.4 4414	4.5 4514	4.6 4712	4.7 3014/16	4.8 4014/16	4.9 4614	4.13 6114
5.13	Blow tube	■	■	■	■	■	■	■	■	■	■
5.14	Unit to regulate compressed air	□	□	□	□	□	□	□	□	□	□
5.16	Unit to regulate compressed air, providing a shut-off valve	-	-	-	-	-	-	-	-	-	□
5.17	Pressure-reducing valve	-	□	□	□	-	-	-	□	-	-

5.13



### Blow tube

to provide support air. To assist label transfer, the label is blown from below to the pad.

Provided for 2", 4" or 6" label applications

5.14



### Unit to regulate compressed air

4.5 bar default setting

Provided in a left-hand or right-hand design

Delivery includes a fine filter, a pressure control valve with a display, a hose to connect to an applicator's compressed air input and material to assemble the unit to a chassis or a bracket.

5.16



### Unit to regulate compressed air, providing a shut-off valve

to vent a hose line subsequent to the unit

Provided in a left-hand or right-hand design

5.17



### Pressure-reducing valve

It reduces the pressure exerted by the stroke cylinder to a product.

Designed for applicators 4014/16, 4114/16, 4214, 4414

## Examples how to assemble a unit to regulate compressed air

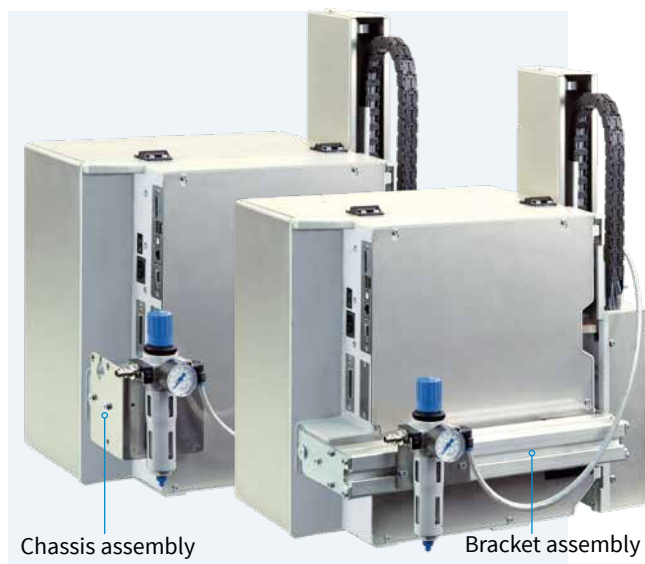

# Tools to assemble HERMES Q

Pos.	Designation	1.1	1.2		1.3
		HERMES Q2	HERMES Q4.3	HERMES Q4	HERMES Q6.3
6.1	Adapter plate	<input type="checkbox"/>	<input type="checkbox"/>	<input type="checkbox"/>	<input type="checkbox"/>
6.2	Profiles 40, 80, 120 mm	<input type="checkbox"/>	<input type="checkbox"/>	<input type="checkbox"/>	<input type="checkbox"/>
6.3	Base plate 500 x 255 mm	<input type="checkbox"/>	<input type="checkbox"/>	<input type="checkbox"/>	-
6.4	Mounting plate	<input type="checkbox"/>	<input type="checkbox"/>	<input type="checkbox"/>	<input type="checkbox"/>
6.5	Bracket	<input type="checkbox"/>	<input type="checkbox"/>	<input type="checkbox"/>	<input type="checkbox"/>
6.6	Clamped joint designed for a 50 x 50 mm profile	<input type="checkbox"/>	<input type="checkbox"/>	<input type="checkbox"/>	<input type="checkbox"/>
6.7	Flanged joint designed for a 50 x 50 mm profile	<input type="checkbox"/>	<input type="checkbox"/>	<input type="checkbox"/>	<input type="checkbox"/>
6.8	Floor stand 1601	<input type="checkbox"/>	<input type="checkbox"/>	<input type="checkbox"/>	<input type="checkbox"/>
6.9	Floor stand 1602	<input type="checkbox"/>	<input type="checkbox"/>	<input type="checkbox"/>	<input type="checkbox"/>
6.10	Floor stand 1201	<input type="checkbox"/>	<input type="checkbox"/>	<input type="checkbox"/>	<input type="checkbox"/>

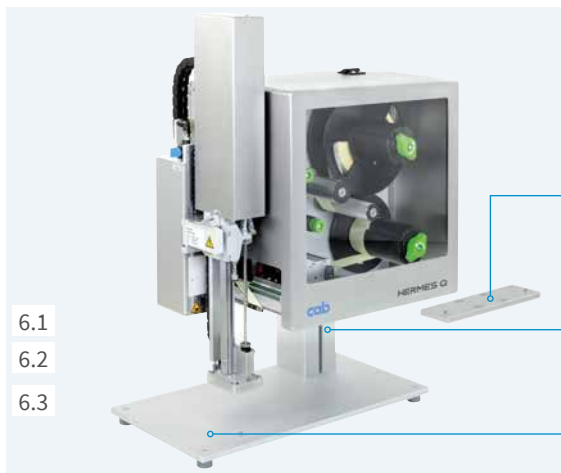

## Mount

to install on a table or to a production line.  
Provided in a left-hand or right-hand design

The size of the mount can be adapted to an application.

### 1 Adapter plate

to fix a label application system.  
Alternatively, it can be assembled directly to a production line, using the adapter plate with a profile.

### 2 Profile

square aluminum; 40, 80, 120 mm are standards, further lengths can be provided on request

### 3 Base plate

to fix the product jig; 500 x 255 mm by default

## Mounting plate

to assemble directly to a production line

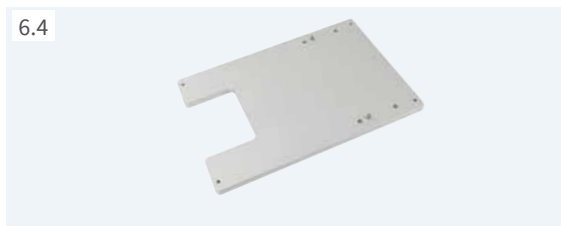

## Bracket

to assemble to a floor stand



## Clamped joint designed for a 50 x 50 mm profile

to move in horizontal or vertical direction

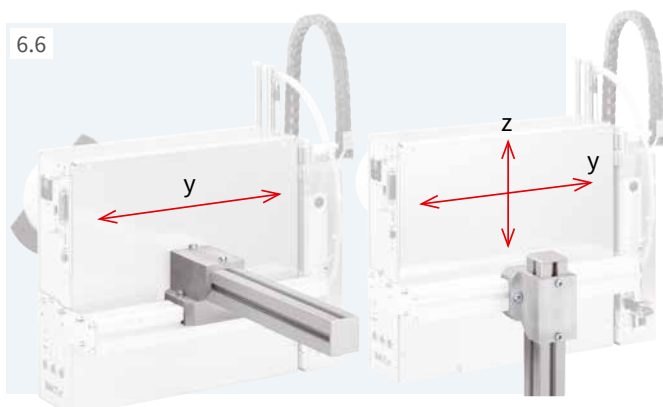

## Flanged joint designed for a 50 x 50 mm profile

to move in horizontal direction or rotate around an axis

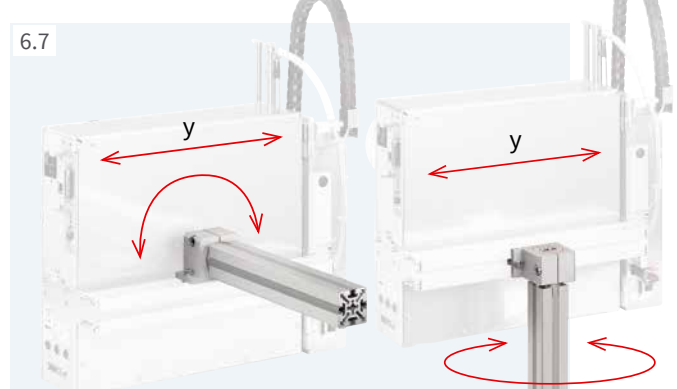

# HERMES Q floor stands

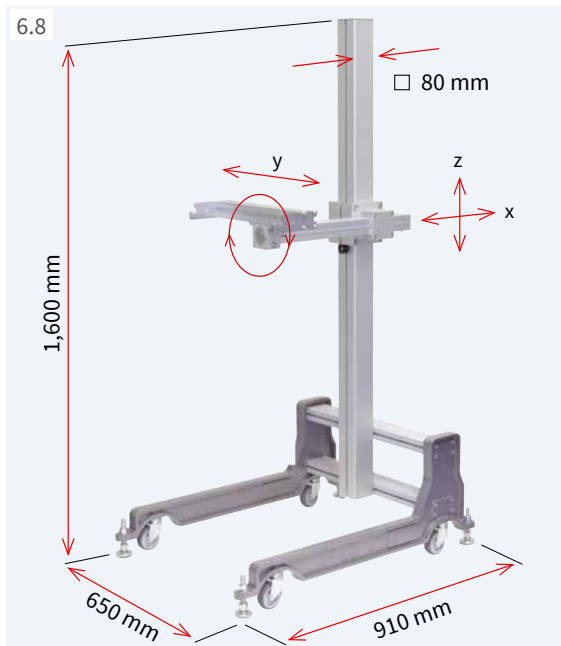

HERMES Q can be installed to a production line and aligned in three axes to the product to label. Pivoting is also possible.

### Floor stand 1601

It benefits when operating HERMES Q in different production lines. Mobility is provided. At the place of operation, the floor stand can be fixed with the help of feet to adjust.

Floor stand	1601
Base frame	castors, feet
Adjustment of heights and depths	screw clamping
Load if offset is 500 mm	up to kg
Weight	kg



### Floor stand 1602

It benefits if positions to apply labels are changing frequently in terms of heights and depths. HERMES Q can be aligned in directions x and z to a product using a toothed rack.

Floor stand	1602
Base frame	feet
Adjustment of heights and depths	toothed rack, crank, toothed rack, handwheel
Load if offset is 500 mm	up to kg
Weight	kg

## Examples how to assemble to a stand

Applying labels in direction of transport from the top from the side

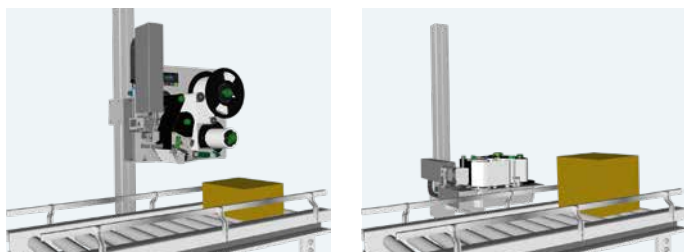

Applying labels crosswise the direction of transport from the top from the side

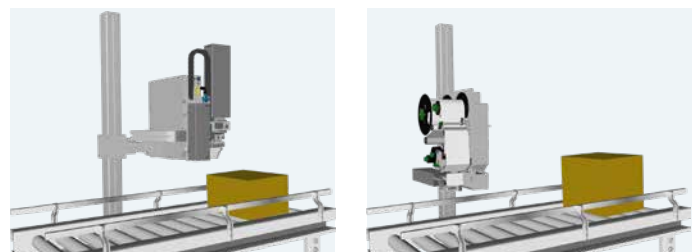

## HERMES Q floor stand

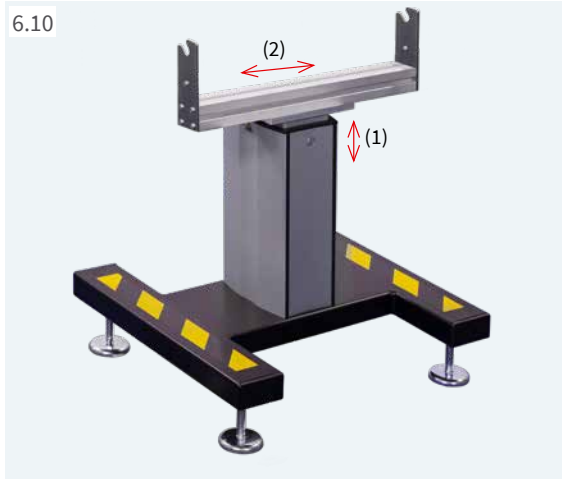

### Floor stand 1201

to assemble HERMES Q horizontally in a production line.  
The height can be adjusted continuous using an integral spindle.

A unit to regulate compressed air can be assembled to the bracket,  
so can a warning light.

Floor stand		1201
Feet to adjust	by mm	± 15
Load	up to kg	75
(1) Lower label margin-floor <sup>1)</sup>	mm	720-960
(2) Depth along direction of transport	mm	± 100
Weight	approx. kg	40

<sup>1)</sup> further dimensions can be provided on request



# HERMES Q delivery program

## Label printers L

Pos.	Part no.	Designation
1.1	<b>6010003</b>	Label printer HERMES Q2L/300-2
	<b>6010004</b>	Label printer HERMES Q2L/600-2
1.2	<b>6010005</b>	Label printer HERMES Q4L/300-2
	<b>6010006</b>	Label printer HERMES Q4L/600-2
	<b>6010007</b>	Label printer HERMES Q4.3L/200-2
	<b>6010008</b>	Label printer HERMES Q4.3L/300-2
1.3	<b>6010009</b>	Label printer HERMES Q6.3L/200-2
	<b>6010010</b>	Label printer HERMES Q6.3L/300-2
1.1	<b>6010011</b>	Label printer HERMES Q2L/300-3
	<b>6010012</b>	Label printer HERMES Q2L/600-3
1.2	<b>6010013</b>	Label printer HERMES Q4L/300-3
	<b>6010014</b>	Label printer HERMES Q4L/600-3
	<b>6010015</b>	Label printer HERMES Q4.3L/200-3
	<b>6010016</b>	Label printer HERMES Q4.3L/300-3
	<b>6010017</b>	Label printer HERMES Q6.3L/200-3
1.3	<b>6010018</b>	Label printer HERMES Q6.3L/300-3

xxxxxxx.250 if HERMES Q provides options

## Label printers R

Pos.	Part no.	Designation
1.1	<b>6010023</b>	Label printer HERMES Q2R/300-2
	<b>6010024</b>	Label printer HERMES Q2R/600-2
1.2	<b>6010025</b>	Label printer HERMES Q4R/300-2
	<b>6010026</b>	Label printer HERMES Q4R/600-2
	<b>6010027</b>	Label printer HERMES Q4.3R/200-2
	<b>6010028</b>	Label printer HERMES Q4.3R/300-2
1.3	<b>6010029</b>	Label printer HERMES Q6.3R/200-2
	<b>6010030</b>	Label printer HERMES Q6.3R/300-2
1.1	<b>6010031</b>	Label printer HERMES Q2R/300-3
	<b>6010032</b>	Label printer HERMES Q2R/600-3
1.2	<b>6010033</b>	Label printer HERMES Q4R/300-3
	<b>6010034</b>	Label printer HERMES Q4R/600-3
	<b>6010035</b>	Label printer HERMES Q4.3R/200-3
	<b>6010036</b>	Label printer HERMES Q4.3R/300-3
1.3	<b>6010037</b>	Label printer HERMES Q6.3R/200-3
	<b>6010038</b>	Label printer HERMES Q6.3R/300-3

xxxxxxx.250 if HERMES Q provides options

### Scope of HERMES Q label printer delivery

HERMES Q label printer  
Power cable Type E+F, 1.8 m  
Connecting USB cable, 1.8 m  
Assembly instructions DE/EN

### Provided online



Assembly instructions DE/EN/FR  
Configuration manuals DE/EN/FR  
Service manuals DE/EN  
Spare parts lists DE/EN  
Programming manual EN  
Windows printer drivers for

Windows 10 Server 2016  
Windows 11 Server 2019  
Server 2022

<https://setup.cab.de/en>

Certification WHQL in preparation  
Apple Mac OS X printer drivers DE/EN/FR  
Linux printer drivers DE/EN/FR  
cablabel S3 Lite software  
cablabel S3 Viewer  
Database Connector

## Options

Pos.	Part no.	Designation
3.1	<b>6010860.250</b>	Automatic ribbon saving 4L
	<b>6010861.250</b>	Automatic ribbon saving 6L
	<b>6010862.250</b>	Automatic ribbon saving 4R
	<b>6010863.250</b>	Automatic ribbon saving 6R
3.2	<b>6010960.250</b>	UHF RFID/4L RS module
	<b>6010961.250</b>	UHF RFID/4L OM module
	<b>on request</b>	UHF RFID/6L RS module
	<b>6010970.250</b>	UHF RFID/4R RS module
	<b>6010971.250</b>	UHF RFID/4R OM module
	<b>on request</b>	UHF RFID/6R RS module
3.3	<b>6010591.xxx</b>	Label unwinder K40/2-2
	<b>6010592.xxx</b>	Label unwinder K40/4-2
	<b>6010593.xxx</b>	Label unwinder K40/6-2
	<b>6010594.xxx</b>	Label unwinder K40/2-3
	<b>6010595.xxx</b>	Label unwinder K40/4-3
	<b>6010596.xxx</b>	Label unwinder K40/6-3
3.4	<b>5961406.xxx</b>	Adapter 40/50
3.5	<b>5961262.xxx</b>	Adapter 76/100
3.6	<b>6010586.xxx</b>	Spacer L
	<b>6010590.xxx</b>	Spacer R
3.7	<b>5961650.xxx</b>	Margin stop 10
3.8	<b>6010500.xxx</b>	Cover 2L F60
	<b>6010933.xxx</b>	Cover 2L F100
	<b>6010501.xxx</b>	Cover 4L F60
	<b>6010937.xxx</b>	Cover 4L F100
	<b>6010502.xxx</b>	Cover 6L F25
	<b>6010503.xxx</b>	Cover 2R F60
	<b>6010939.xxx</b>	Cover 2R F100
	<b>6010504.xxx</b>	Cover 4R F60
	<b>6010941.xxx</b>	Cover 4R F100
	<b>6010505.xxx</b>	Cover 6R F25
	<b>6010840.xxx</b>	Print head pressure system 2L
	<b>6010841.xxx</b>	Print head pressure system 4L
	<b>6010842.xxx</b>	Print head pressure system 6L
	<b>6010843.xxx</b>	Print head pressure system 2R
	<b>6010844.xxx</b>	Print head pressure system 4R
	<b>6010845.xxx</b>	Print head pressure system 6R
3.10	<b>6010557.xxx</b>	Extended peel-off plate (+10 mm) 2L
	<b>6010558.xxx</b>	Extended peel-off plate (+10 mm) 4L
	<b>6010559.xxx</b>	Extended peel-off plate (+10 mm) 6L
	<b>6010563.xxx</b>	Extended peel-off plate (+10 mm) 2R
	<b>6010564.xxx</b>	Extended peel-off plate (+10 mm) 4R
	<b>6010565.xxx</b>	Extended peel-off plate (+10 mm) 6R
3.11	<b>5954978.xxx</b>	Print roller DRS2
	<b>5954985.xxx</b>	Print roller DRS4
	<b>5954979.xxx</b>	Print roller DRS6
3.12	<b>5961640.xxx</b>	Antistatic brush 2L
	<b>5961644.xxx</b>	Antistatic brush 4L
	<b>5961642.xxx</b>	Antistatic brush 2R
	<b>5961646.xxx</b>	Antistatic brush 4R
3.13	<b>5961750.xxx</b>	Draw roller ZS2
	<b>5961751.xxx</b>	Draw roller ZS4
	<b>5961752.xxx</b>	Draw roller ZS6
3.14	<b>5591816.xxx</b>	Interface for plugging an external label sensor
3.15	<b>6010520.xxx</b>	2 port Ethernet switch 10/100 Mbit/s
3.16	<b>5977487.xxx</b>	Label sensor L, modified
	<b>6010498.xxx</b>	Label sensor R, modified















xxx - .250 assembled to the printer  
.001 delivered separately



Information is available also on the Internet:  
[www.cab.de/en/hermesq](http://www.cab.de/en/hermesq)

# HERMES Q delivery program

## Accessories

Pos.	Part no.	Designation
2.1	 5977370	SD memory card
2.2	 5977730	USB memory stick
2.3	 5978912	USB WLAN stick 2.4 GHz 802.11b/g/n
2.4	 5977731	USB WLAN stick including a rod antenna 2.4 GHz 802.11b/g/n + 5 GHz a/n/ac
2.6	 5970071	Product sensor, 3 pins
2.7	 5964300	Product sensor, 25 pins
2.8	 5917651	I/O interface connector SUB-D, 25 pins
2.9	 6010560	Warning light
2.10	 6010186	External operation panel
	5907718.850	Connecting USB cable, 1.8 m
	5907730.850	Connecting USB cable, 3 m
	5907750.850	Connecting USB cable, 5 m
	5907760.850	Connecting USB cable, 11 m
5907765.850	Connecting USB cable, 16 m	
2.11	 5948205	Label selection - I/O box
2.12	 5955710	Hand switch TR2
2.13	 5955711	Foot switch
2.14	 5550818	Connecting RS232 C cable 9/9 pins, 3 m
2.15	 on request	Scanner CC200

## Label software

Pos.	Part no.	Designation
7.6	Bundle	cablabel S3 Lite (download on cab.de/en)
	5588001	cablabel S3 Pro, 1 WS
	5588100	cablabel S3 Pro, 5 WS
	5588101	cablabel S3 Pro, 10 WS
	5588150	cablabel S3 Pro, 1 additional licence
	5588151	cablabel S3 Pro, 4 additional licences
	5588152	cablabel S3 Pro, 9 additional licences
	5588002	cablabel S3 Print, 1 WS
	5588105	cablabel S3 Print, 5 WS
	5588106	cablabel S3 Print, 10 WS
7.10	5588155	cablabel S3 Print, 1 additional licence
	5588156	cablabel S3 Print, 4 additional licences
	5588157	cablabel S3 Print, 9 additional licences
	in preparation	cablabel S3 Print Server
	9008486	Programming manual EN, printed copy

Scopes of delivery, design and technical specifications correspond to the date of the printing. Subject to change. The data provided in the catalog do not represent any warranty or guarantee.

## Wear parts











Pos.	Part no.	Designation	dpi
	5977384.001	Print head 2	300
	5977385.001	Print head 2	600
	5977444.001	Print head 4	300
	5977380.001	Print head 4	600
	5977382.001	Print head 4.3	200
	5977383.001	Print head 4.3	300
	5977386.001	Print head 6.3	200
	5977387.001	Print head 6.3	300
	5954102.001	Print roller DR2	
	5954180.001	Print roller DR4	
	5954245.001	Print roller DR6	
	5961015.001	Draw roller ZR2	
	5961298.001	Draw roller ZR4	
	5961220.001	Draw roller ZR6	
	Pos.	Part no.	OM operation, RFID antenna assembled
		5987177.001	Print head 4.3/200 RFID
5987178.001		Print head 4.3/300 RFID	
5987179.001		Print head 4/300 RFID	
5987180.001		Print head 4/600 RFID	
5987808.001		Print head 6.3/200 RFID	
	5987809.001	Print head 6.3/300 RFID	

## User languages

Language	Assembly instructions	Control panel	Windows driver	Service manual	cablabel S3
<b>European Union</b>					
Bulgarian		X	X		X
Danish	X	X	X		
German	X	X	X	X	X
Estonian		X	X		
Finnish	X	X	X		
French	X	X	X		X
Greek		X	X		
English	X	X	X	X	X
Italian	X	X	X		X
Croatian		X	X		
Latvian		X	X		
Lithuanian		X	X		
Dutch	X	X	X		
Polish	X	X	X		X
Portuguese	X	X	X		
Romanian	X	X	X		
Swedish	X	X	X		
Slovak		X	X		
Slovenian	X	X	X		
Spanish	X	X	X		X
Czech	X	X	X		X
Hungarian	X	X	X		
<b>Europe (Non-EU)</b>					
Macedonian		X	X		
Norwegian		X	X		
Russian	X	X	X		X
Serbian		X	X		
Turkish		X	X		
<b>Asia</b>					
Chinese (simplified)	X	X	X		X
Chinese (traditional)	X	X	X		X
Japanese			X		
Korean	X		X		X
Thai		x	X		
<b>Middle East</b>					
Arabian		X			
Persian		X			

# HERMES Q delivery program



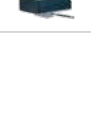









## Applicators L

Pos.	Part no.	Designation	Part no.	Transfer modules
4.1	 5970075	Swing applicator 3214L-40	xxxxxxx xxxxxxx xxxxxxx xxxxxxx	Tamp-on pad 3214L-11 F W x H Tamp-on pad, providing a damping layer 3214L-12 F W x H Tamp-on pad, providing a label stop 3214L-61 F W x H Blow-on pad 3214L-2100 W x H
4.2	 5966109 5966110 5966111	Stroke applicator 4114L-200 Stroke applicator 4114L-300 Stroke applicator 4114L-400	xxxxxxx xxxxxxx xxxxxxx xxxxxxx	Tamp-on pad 4114L-11 F W x H Tamp-on pad, providing a damping layer 4114L-12 F W x H Tamp-on pad, providing a label stop 4114L-61 F W x H Blow-on pad 4114L-2100 W x H Form pad 4114L-8800 W x H
		5971795 5972016 5972017	Stroke applicator 4116L-200 Stroke applicator 4116L-300 Stroke applicator 4116L-400	xxxxxxx xxxxxxx xxxxxxx xxxxxxx
4.3	 5966117 5966118 5966119	Stroke turn applicator 4214L-200 Stroke turn applicator 4214L-300 Stroke turn applicator 4214L-400	xxxxxxx xxxxxxx xxxxxxx xxxxxxx	Tamp-on pad 4214L-11 F W x H Tamp-on pad, providing a damping layer 4214L-12 F W x H Tamp-on pad, providing a label stop 4214L-61 F W x H Blow-on pad 4214L-2100 W x H
4.4	 5966133 5966134 5966135	Stroke applicator 4414L-200 Stroke applicator 4414L-300 Stroke applicator 4414L-400	xxxxxxx xxxxxxx xxxxxxx	Tamp-on pad 4414L-11 F W x H Tamp-on pad, providing a damping layer 4414L-12 F W x H Tamp-on pad, providing a label stop 4414L-61 F W x H
4.5	 5971625 5966168 5971640	Swing stroke applicator 4514L-200 Swing stroke applicator 4514L-300 Swing stroke applicator 4514L-400	xxxxxxx	Blow-on pad 4514L-2100 W x H
4.6	 5971815	Flag applicator 4712L-300	xxxxxxx	Form pad ..... W x H
4.7	 5970100 5970101 5970102	Front side applicator 3014L-200 Front side applicator 3014L-300 Front side applicator 3014L-400	xxxxxxx xxxxxxx xxxxxxx	Tamp-on pad 3014L-1100 W x H Tamp-on pad, spring-mounted 3014L-3100 W x H Blow-on pad 3014L-2100 W x H
		5970103 5970104 5970105	Front side applicator 3016L-200 Front side applicator 3016L-300 Front side applicator 3016L-400	xxxxxxx xxxxxxx
4.8	 5966101 5966102 5966103	Stroke applicator 4014L-200 Stroke applicator 4014L-300 Stroke applicator 4014L-400	5966147 5966148 5966149 5966150	Universal pad 4014L-1100 75 x 60 Universal pad 4014L-1100 90 x 90 Universal pad, spring-mounted 4014L-3100 116 x 102 Universal pad, spring-mounted 4014L-3100 116 x 152
			xxxxxxx xxxxxxx xxxxxxx xxxxxxx	Tamp-on pad 4014L-11 F W x H Blow-on pad 4014L-2100 W x H Tamp-on pad, spring-mounted 4014L-3100 W x H Roll-on pad 4014L-4100 W x H Corner-wrap pad 4014L-5100 W x H / H
		5966161 5966162 5966163	Stroke applicator 4016L-200 Stroke applicator 4016L-300 Stroke applicator 4016L-400	xxxxxxx xxxxxxx xxxxxxx
4.9	 5971720 5971725 5971730	Stroke blow applicator 4614L-200 Stroke blow applicator 4614L-300 Stroke blow applicator 4614L-400	xxxxxxx	Blow-on pad 4614L-2100 W x H
4.10	 6010890 5966144 5966146	Demand module 5112L Demand module 5114L Demand module 5116L		
4.11	 5972730 5972750	Vacuum belt applicator 5314L-3 Vacuum belt applicator 5316L-3		
4.12		5972940 5972920	Vacuum belt applicator 5414L-3 Vacuum belt applicator 5416L-3	
4.13	 5984810	Air jet box 6114L 5 templates are included	5984709.001	Template 6114 L/R 5 items are included in a pack unit







# HERMES Q delivery program







## Applicators R

Pos.		Part no.	Designation		Part no.	Transfer modules
4.1		<b>5971655</b>	Swing applicator	3214R-40	xxxxxxx xxxxxxx xxxxxxx xxxxxxx	Tamp-on pad 3214R-11 F W x H Tamp-on pad, providing a damping layer 3214R-12 F W x H Tamp-on pad, providing a label stop 3214R-61 F W x H Blow-on pad 3214R-2100 W x H
4.2		<b>5966113</b>	Stroke applicator	4114R-200	xxxxxxx xxxxxxx xxxxxxx xxxxxxx xxxxxxx	Tamp-on pad 4114R-11 F W x H Tamp-on pad, providing a damping layer 4114R-12 F W x H Tamp-on pad, providing a label stop 4114R-61 F W x H Blow-on pad 4114R-2100 W x H Form pad 4114R-8800 W x H
		<b>5966114</b> <b>5966115</b>	Stroke applicator Stroke applicator	4114R-300 4114R-400		
4.2		<b>5972018</b>	Stroke applicator	4116R-200	xxxxxxx xxxxxxx xxxxxxx xxxxxxx	Tamp-on pad 4116R-11 F W x H Tamp-on pad, providing a damping layer 4116R-12 F W x H Tamp-on pad, providing a label stop 4116R-61 F W x H Form pad 4116R-8800 W x H
		<b>5972019</b> <b>5972020</b>	Stroke applicator Stroke applicator	4116R-300 4116R-400		
4.3		<b>5966121</b> <b>5966122</b> <b>5966123</b>	Stroke turn applicator Stroke turn applicator Stroke turn applicator	4214R-200 4214R-300 4214R-400	xxxxxxx xxxxxxx xxxxxxx xxxxxxx	Tamp-on pad 4214R-11 F W x H Tamp-on pad, providing a damping layer 4214R-12 F W x H Tamp-on pad, providing a label stop 4214R-61 F W x H Blow-on pad 4214R-2100 W x H
4.4		<b>5966137</b> <b>5966138</b> <b>5966139</b>	Stroke applicator Stroke applicator Stroke applicator	4414R-200 4414R-300 4414R-400	xxxxxxx xxxxxxx xxxxxxx	Tamp-on pad 4414R-11 F W x H Tamp-on pad, providing a damping layer 4414R-12 F W x H Tamp-on pad, providing a label stop 4414R-61 F W x H
4.5		<b>5966950</b> <b>5971460</b> <b>5971700</b>	Swing stroke applicator Swing stroke applicator Swing stroke applicator	4514R-200 4514R-300 4514R-400	xxxxxxx	Blow-on pad 4514R-2100 W x H
4.7		<b>5970106</b> <b>5970107</b> <b>5970108</b>	Front side applicator Front side applicator Front side applicator	3014R-200 3014R-300 3014R-400	xxxxxxx xxxxxxx xxxxxxx	Tamp-on pad 3014R-1100 W x H Tamp-on pad, spring-mounted 3014R-3100 W x H Blow-on pad 3014R-2100 W x H
		<b>5970109</b> <b>5970110</b> <b>5970111</b>	Front side applicator Front side applicator Front side applicator	3016R-200 3016R-300 3016R-400	xxxxxxx xxxxxxx	Tamp-on pad 3016R-1100 W x H Tamp-on pad, spring-mounted 3016R-3100 W x H
4.8		<b>5966105</b> <b>5966106</b> <b>5966107</b>	Stroke applicator Stroke applicator Stroke applicator	4014R-200 4014R-300 4014R-400	<b>5966140</b> <b>5966141</b> <b>5966142</b> <b>5966143</b>	Universal pad 4014R-1100 75 x 60 Universal pad 4014R-1100 90 x 90 Universal pad, spring-mounted 4014R-3100 116 x 102 Universal pad, spring-mounted 4014R-3100 116 x 152
		<b>5966165</b> <b>5966166</b> <b>5966167</b>	Stroke applicator Stroke applicator Stroke applicator	4016R-200 4016R-300 4016R-400	xxxxxxx xxxxxxx xxxxxxx	Tamp-on pad 4016R-11 F W x H Tamp-on pad, spring-mounted 4016R-3100 W x H Roll-on pad 4016R-4100 W x H
4.9		<b>5971735</b> <b>5971740</b> <b>5971745</b>	Stroke blow applicator Stroke blow applicator Stroke blow applicator	4614R-200 4614R-300 4614R-400	xxxxxxx	Blow-on pad 4614R-2100 W x H
4.10		<b>6010910</b> <b>5966145</b> <b>5966152</b>	Demand module Demand module Demand module	5112R 5114R 5116R		
4.11		<b>5972740</b> <b>5972760</b>	Vacuum belt applicator Vacuum belt applicator	5314R-3 5316R-3		
4.12		<b>5972950</b> <b>5972930</b>	Vacuum belt applicator Vacuum belt applicator	5414R-3 5416R-3		
4.13		<b>5984800</b>	Air jet box 5 templates are included	6114R	<b>5984709.001</b>	Template 6114 L/R 5 items are included in a pack unit



## Accessories and options provided for applicators

Pos.		Part no.	Designation
5.13		<b>5964277.001</b> <b>5964095.001</b> <b>5964614.001</b>	Blow tube 2" Blow tube 4" Blow tube 6"
5.14		<b>6010880</b> <b>6010881</b>	Unit L to regulate compressed air Unit R to regulate compressed air
5.16		<b>5984805</b> <b>5984795</b>	Unit L to regulate compressed air, providing a shut-off valve Unit R to regulate compressed air, providing a shut-off valve
5.17		<b>596xxxx.212</b>	Pressure-reducing valve
		<b>xxxx</b> - applicator part no.	

## Tools to assemble

Pos.		Part no.	Designation
6.1		<b>5965940</b>	Adapter plate
6.2		on request	Profile (customer-specific lengths)
6.3		<b>5961203</b>	Base plate 500 x 255 mm
6.4		<b>5958400</b>	Mounting plate
6.5		<b>5955685</b>	Bracket
6.6		<b>8914443</b>	Clamped joint designed for a 50 x 50 mm profile
6.7		<b>8914444</b>	Flanged joint designed for a 50 x 50 mm profile

## Floor stands

Pos.		Part no.	Designation
6.8		<b>5970113</b>	Floor stand 1601
6.9		<b>5970112</b>	Floor stand 1602
6.10		<b>5972515</b>	Floor stand 1201

# Overview of cab products

Label printers  
**MACH1, MACH2**



Label printers  
**EOS 2**



Label printers  
**EOS 5**



Label printers  
**MACH 4S**



Label printers  
**SQUIX 2**



Label printers  
**SQUIX 4**



Label printers  
**SQUIX 6.3**



Label printers  
**SQUIX 8.3**



Label printers  
**XD Q double-sided**



Label printers  
**XC Q two-colored**



Print and apply systems  
**HERMES Q**



Print and apply systems  
**Hermes C two-colored**

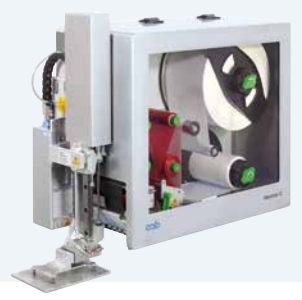

Tube labeling systems  
**AXON 1**



Print modules  
**PX Q**



Labels and ribbons



Label software  
**cablabel S3**



Label dispensers  
**HS, VS**



Labeling heads  
**IXOR**



Marking lasers  
**XENO 4**



Laser marking systems



Germany

**cab Produkttechnik GmbH & Co KG**

Karlsruhe

Phone +49 721 6626 0

[www.cab.de](http://www.cab.de)

France

**cab Technologies S.à.r.l.**

Niedermodern

Phone +33 388 722501

[www.cab.de/fr](http://www.cab.de/fr)

USA

**cab Technology, Inc.**

Chelmsford, MA

Phone +1 978 250 8321

[www.cab.de/us](http://www.cab.de/us)

Mexico

**cab Technology, Inc.**

Juárez

Phone +52 656 682 4301

[www.cab.de/es](http://www.cab.de/es)

Taiwan

**cab Technology Co., Ltd.**

Taipei

Phone +886 (02) 8227 3966

[www.cab.de/tw](http://www.cab.de/tw)

China

**cab (Shanghai) Trading Co., Ltd.**

Shanghai

Phone +86 (021) 6236 3161

[www.cab.de/cn](http://www.cab.de/cn)

Singapore

**cab Singapore Pte. Ltd.**

Singapore

Phone +65 6931 9099

[www.cab.de/en](http://www.cab.de/en)

South Africa

**cab Technology (Pty) Ltd.**

Randburg

Phone +27 11 886 3580

[www.cab.de/za](http://www.cab.de/za)

**cab // 820** distribution and service partners in more than **80** countries